

# RIHO

*čistá krása*  
*Pure beauty*  
*Чистая красота*

vany / sprchové zástěny / koupelnový nábytek  
bathtubs / shower screens / furniture  
ванны / душевые шторы / мебель



# WELLNESS 2013



# RIHO

*čistá krása*  
*Pure beauty*  
*Чистая красота*

vany / sprchové zástěny / koupelnový nábytek  
bathtubs / shower screens / furniture  
ванны / душевые шторы / мебель

# WELLNESSES 2013

# OBSAH / CONTENT / СОДЕРЖАНИЕ

VANY / BATHTUBS / ВАННЫ

7-58

|  |              |
|--|--------------|
| <b>LITÉ VANY</b><br>SOLID SURFACE BATHTUBS/ВАННЫ ИЗ ЛИТОГО МРАМОРА                                 | <b>7-10</b>  |
| <b>AKRYLÁTOVÉ VANY/ACRYLIC BATHTUBS/АКРИЛАТНЫЕ ВАННЫ</b>   |              |
| <b>OBDELNÍKOVÉ</b><br>RECTANGULAR / ПРЯМОУГОЛЬНЫЕ  | <b>11-25</b> |
| <b>ASYMETRICKÉ</b><br>ASYMETRICAL / АСИММЕТРИЧНЫЕ  | <b>25-27</b> |
| <b>ROHOVÉ</b><br>CORNER/УГЛОВЫЕ  | <b>27-29</b> |
| <b>DESIGNOVÉ</b><br>DESIGN/ВАННЫ ДРУГИХ ФОРМ   | <b>29-31</b> |
| <b>PODPĚRY K VANÁM</b><br>LEGSETS/НОЖКИ ДЛЯ ВАНН   | <b>32-33</b> |
| <b>MASÁŽNÍ SYSTÉMY</b><br>MASSAGE SYSTEMS/МАССАЖНЫЕ СИСТЕМЫ  | <b>34-39</b> |
| <b>PŘÍSLUŠENSTVÍ</b><br>ACCESSORIES/АКЦЕССУАРЫ   | <b>40-45</b> |
| <b>KRYCÍ PANELY</b><br>COVER PANELS/ЗАЩИТНЫЕ ПАНЕЛИ  | <b>42-43</b> |
| <b>DOPLŇKY</b><br>THE ACCESSORIES/ДОПОЛНИТЕЛЬНОЕ ОБОРУДОВАНИЕ                                      | <b>44</b>    |
| <b>VANOVÉ ZÁSTĚNY</b><br>BATHTUB SCREENS/ШТОРКИ ДЛЯ ВАНН   | <b>46-47</b> |
| <b>THERMAE LINE-SPECIÁLNÍ MASÁŽNÍ VANY</b><br>SPECIAL MASSAGE BATHTUBS/СПЕЦИАЛЬНЫЕ МАССАЖНЫЕ ВАННЫ | <b>48-57</b> |
| <b>INFORMACE</b><br>INFORMATION/ИНФОРМАЦИЯ   | <b>58</b>    |

**SPRCHOVÉ ZÁSTĚNY, VANIČKY/SHOWER SCREENS, TRAYS/ДУШЕВЫЕ ШТОРКИ, ДУШЕВЫЕ ПОДДОНЫ** 59-107

|   |               |
|---|---------------|
| <b>SPRCHOVÉ ZÁSTĚNY</b><br>SHOWER SCREENS/ДУШЕВЫЕ ШТОРКИ                          | <b>59-83</b>  |
| <b>INFORMACE</b><br>INFORMATION/ИНФОРМАЦИЯ  | <b>84-87</b>  |
| <b>SPRCHOVÉ VANIČKY</b><br>SHOWER TRAYS/ДУШЕВЫЕ ПОДДОНЫ                           | <b>90-92</b>  |
| <b>PODLAHOVÉ ŽLABY</b><br>STAINLESS STEEL SHOWER DRAINS/НЕРЖАВЕЮЩИЕ ДУШЕВЫЕ ТРАПЫ | <b>93-107</b> |

**PARNÍ KABINY / STEAM CABINS / ПАРОВЫЕ КАБИНЫ** 109-117

**NÁBYTEK / FURNITURE / МЕБЕЛЬ** 118-195









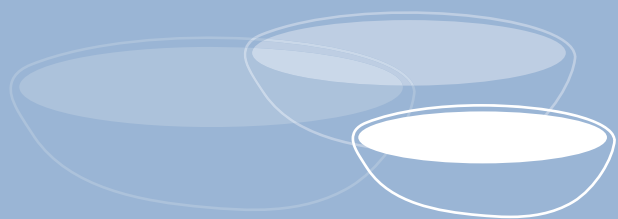







ANDORA, BOLOGNA, BRONI, EIFEL, ELZAS, ESTÉE, EVRY, LIGNA,  
LUCCA, SLIMLINE, SMARTLINE, SCALA, AVANTI, VOLANO



VANY

BATHTUBS/БАННЫ



|  |  |
|--|--|
|     | Aero / Aero / Аэро   |
|    | Hydro / Hydro / Гидро  |
|    | Hydro/Aero / Hydro/Aero / Гидро/Аэро   |
|    | Mechanická výpusť s přepadem - délka 57 cm / Mechanical discharge with overflow - size 57 cm / Механический выпуск с перепадом - длина 57 см                 |
|    | Mechanická výpusť s přepadem - délka 70 cm / Mechanical discharge with overflow - size 70 cm / Механический выпуск с перепадом - длина 70 см                 |
|    | Mechanická výpusť s přepadem - délka 70 cm WP / Mechanical discharge with overflow - size 70 cm WP / Механический выпуск с перепадом - длина 70 cm WP        |
|    | Mechanická výpusť s přepadem - délka 100 cm / Mechanical discharge with overflow - size 100 cm / Механический выпуск с перепадом - длина 100 см              |
|    | Mech. výpusť s napouštěním přepadem - délka 57 cm / Mechanical discharge with overflow filling - size 57 cm / Выпуск с наполнением и переливом - длина 57cm  |
|    | Mech. výpusť s napouštěním přepadem - délka 70 cm / Mechanical discharge with overflow filling - size 70 cm / Выпуск с наполнением и переливом - длина 70 cm |
|    | Madlo / Handgrip / Ручка   |
|    | Madlo s napouštěním / Handgrip with overflow filling / Ручка с наливом воды  |
|    | Madlo Thermae / Handgrip Thermae / Ручка Thermae   |
|    | Krycí panel / Cover panel / Защитный панель  |
|   | Dřevěný panel / Wooden cover panel / Деревянный покрывающий панель   |
|  | Vanová zástěna / Bathtub screen / Душевая шторка   |
|  | Podhlavník / Headrest / Подголовник  |
|  | Pevná opěrka hlavy / Fixed headrest / Фиксированный подголовник  |
|  | Podhlavník Thermae / Headrest Thermae / Подголовник Thermae  |
|  | Podpěry universal / Legs universal / Ножки Universal   |
|  | Podpěry special / Legs special / Ножки special   |
|  | Podpěry strong / Legs strong / Ножки strong  |
|  | Osvětlení / Light / Освещение  |
|  | LCD displej / LCD display / LCD дисплей  |
|  | LCD PRO / LCD PRO / LCD PRO  |
|  | LCD LUX / LCD LUX / LCD LUX  |
|  | Přihřev / Heating / Обогрев  |
|  | Krycí deska / Coverplate / Защитная доска  |
|  | Colour terapie / Colour therapy / Хромотерапия   |
|  | Automatická čistící jednotka / Cleansystem / Автоматическая система дезинфекции  |
|  | Výška vany s podpěrami více než 60 cm / Tub height with legset more than 60 cm / Высота ванны с ножками более чем 60 см                                      |
|  | Poloha ve vaně vzhledem k umístění mikrotrysek / Position on the bath regarding the placement of microjets / Позиция согласна в зависимости от микрофорсунок |

LITÉ VANY/SOLID SURFACE BATHTUBS/ВАННЫ ИЗ ЛИТОГО МРАМОРА



**BARCELONA** BS 05 170 x 70 cm / 275 l

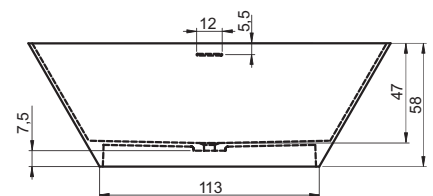
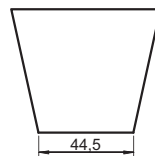
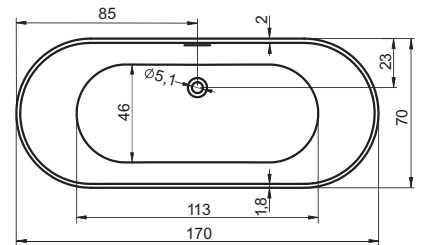

**BILBAO** BS 10 170 x 80 cm / 355 l  
 BS 12 150 x 75 cm / 285 l

NEW

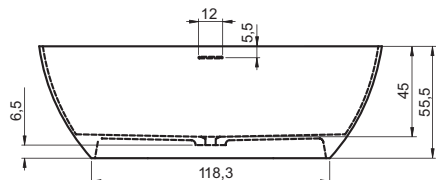
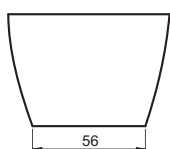
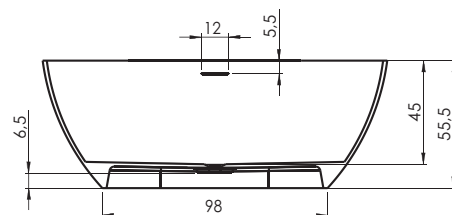
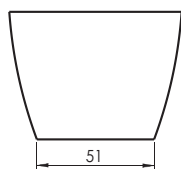
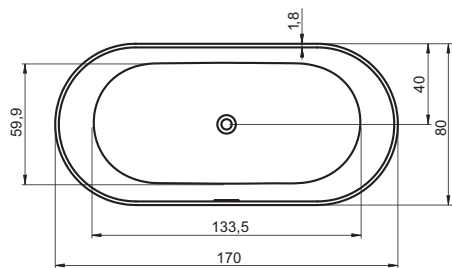
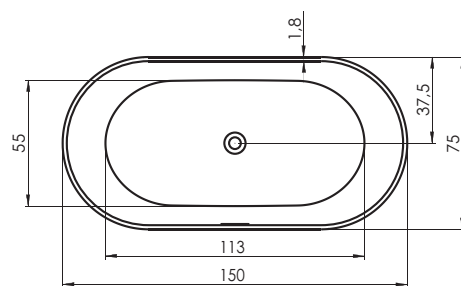

**GRANADA** BS 20 190 x 90 cm / 415 l

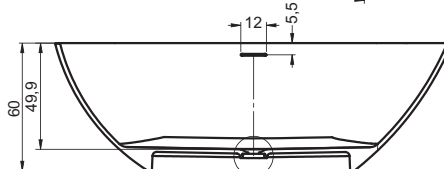
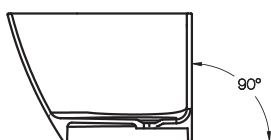
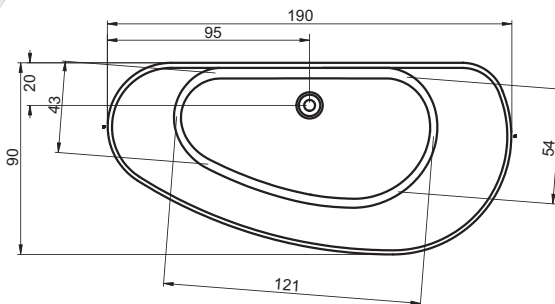

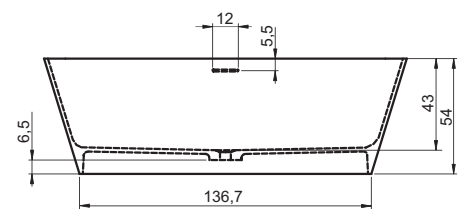
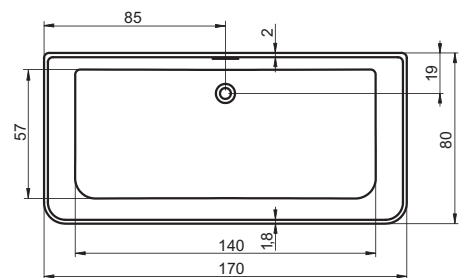
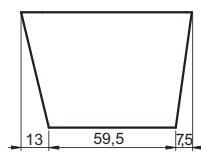
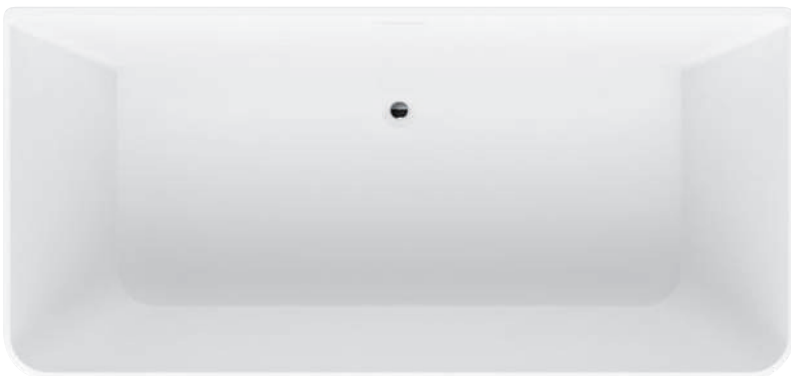

# AKRYLÁTOVÉ VANY/ACRYLIC BATHTUBS/АКРИЛАТНЫЕ ВАННЫ

**COLUMBIA** BA05 140 x 70 cm / 175 l

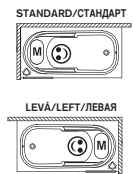
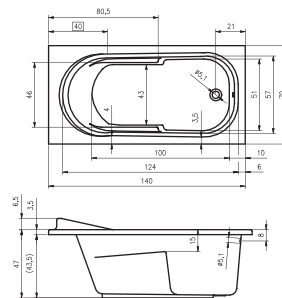

**MIAMI** BB58 150 x 70 cm / 160 l

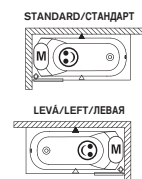
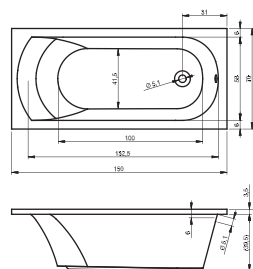

**COLUMBIA** BA02 150 x 75 cm / 190 l

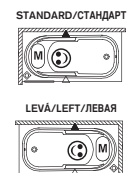
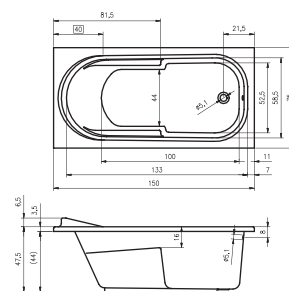

**KLASIK** BZ22 150 x 70 cm / 165 l

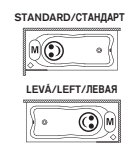
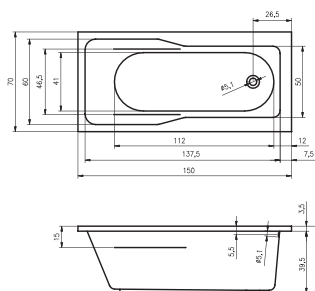

**LIMA** L BB41 / R BB40 150 x 70 cm / 160 l

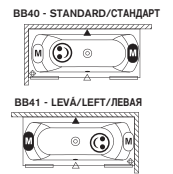
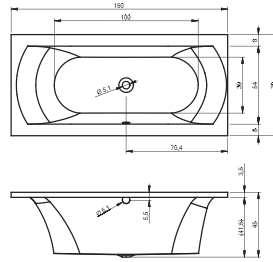

**LIMA** L BB43 / R BB42 160 x 70 cm / 175 l

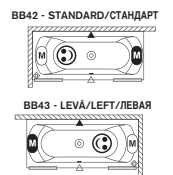
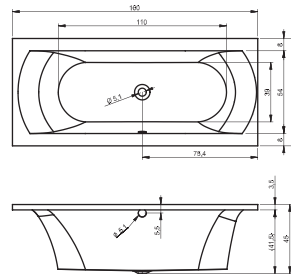

**JULIA** BA71 160 x 70 cm / 275 l

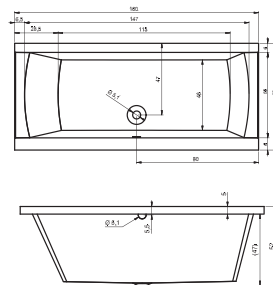

\* Při použití krycího panelu nutno zapustit sifon do podlahy  
 /When cover panel is used siphon has to be embedded in the floor  
 /При использовании покрывающей панели сифон следует утопить в пол

**MIAMI** BB60 160 x 70 cm / 170 l

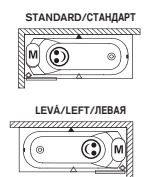
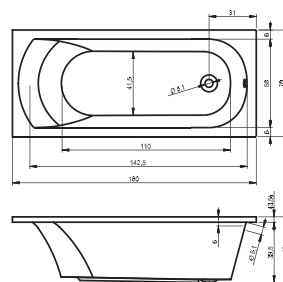



## CAROLINA BB53 170 x 80 cm / 270 l

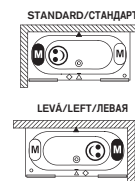
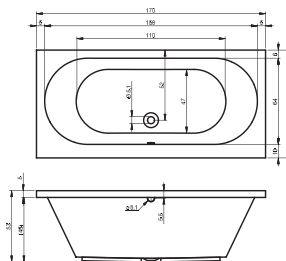

\* Při použití krycího panelu nutno zapustit sifon do podlahy  
 /When cover panel is used siphon has to be embedded in the floor  
 /При использовании покрывающей панели сифон следует утопить в пол

## DORADO L BA81 / R BA80 170 x 75/90 cm / 285 l

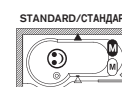
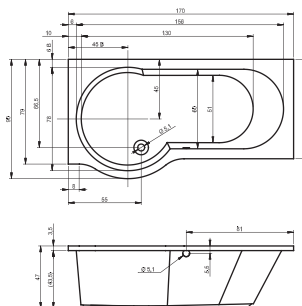

## FUTURE BC28 170 x 75 cm / 195 l

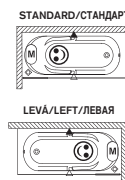
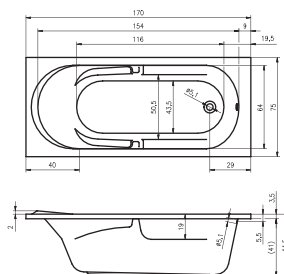

## LIMA L BB45 / R BB44 170 x 75 cm / 210 l

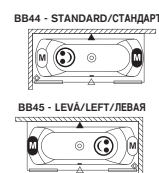
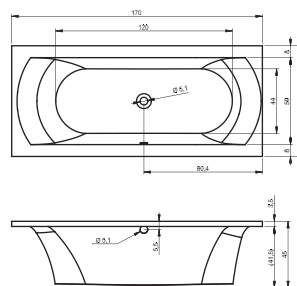

**LUSSO** BA18 170 x 75 cm / 250 l

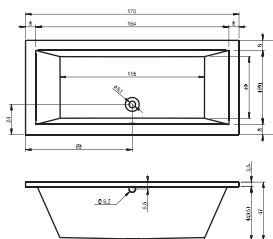

STANDARD/СТАНДАРТ

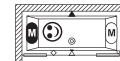

LEVÁ/LEFT/ЛЕВАЯ

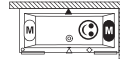

**ORION** BC01 170 x 70 cm / 230 l

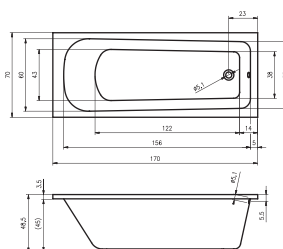

STANDARD/СТАНДАРТ

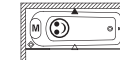

LEVÁ/LEFT/ЛЕВАЯ

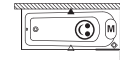

**TAURUS** BC07 170 x 80 cm / 235 l

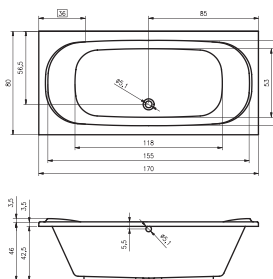

STANDARD/СТАНДАРТ

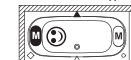

LEVÁ/LEFT/ЛЕВАЯ



**LUSSO PLUS** BA12 170 x 80 cm / 295 l

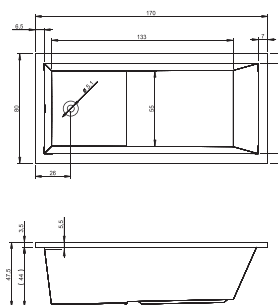

STANDARD/СТАНДАРТ

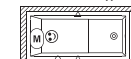

LEVÁ/LEFT/ЛЕВАЯ



**VIRGO** BZ07 170 x 75 cm / 235 l

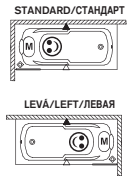
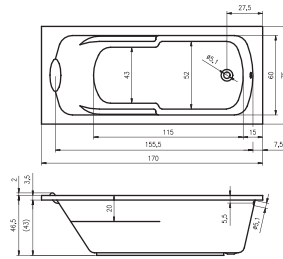

**KLASIK** BZ19 170 x 70 cm / 210 l

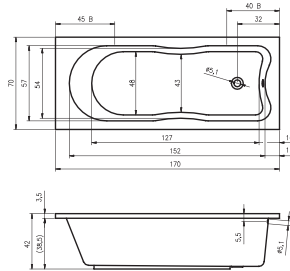

**COLUMBIA** BA04 175 x 80 cm / 255 l

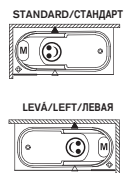
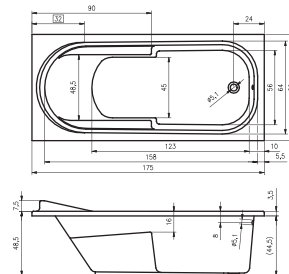

**MIAMI** BB64 180 x 80 cm / 220 l

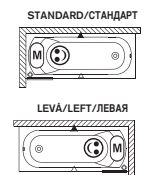
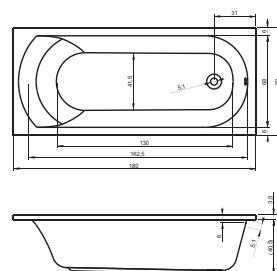

## CAROLINA BB54 180 x 80 cm / 290 l

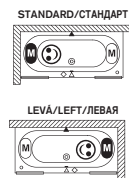
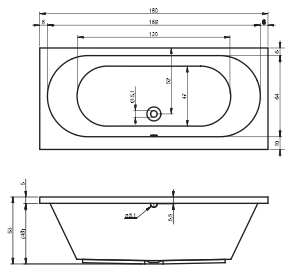

\* Při použití krycího panelu nutno zapustit sifon do podlahy  
 /When cover panel is used siphon has to be embedded in the floor  
 /При использовании покрывающей панели сифон следует утопить в пол

## SUPREME BA55 180 x 80 cm / 230 l

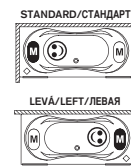
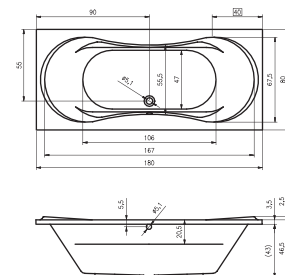

## DAYTONA BB51 180 x 80 cm / 290 l

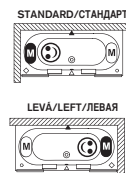
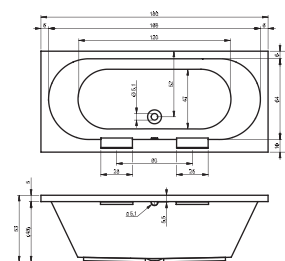

\* Při použití krycího panelu nutno zapustit sifon do podlahy  
 /When cover panel is used siphon has to be embedded in the floor  
 /При использовании покрывающей панели сифон следует утопить в пол

## FUTURE BC31 180 x 80 cm / 225 l

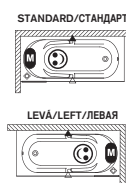
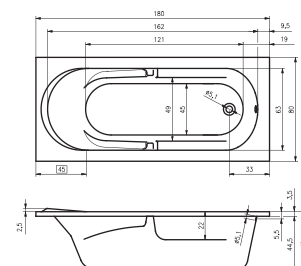

**LIMA** L BB47 / R BB46 180 x 80 cm / 275 l

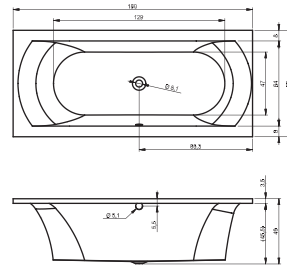

BB46 - STANDARD/СТАНДАРТ

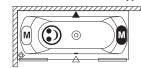

BB47 - LEVÁ/LEFT/ЛЕВАЯ

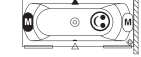

**LIVORNO** BB72 180 x 80 cm / 270 l

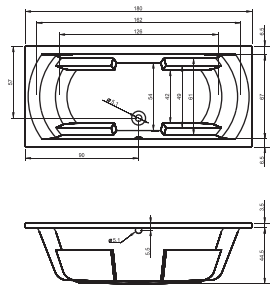

STANDARD/СТАНДАРТ

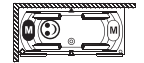

LEVÁ/LEFT/ЛЕВАЯ

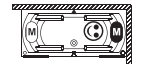

**LUSSO** BA98 180 x 80 cm / 295 l

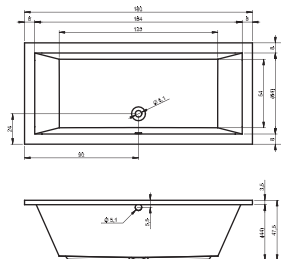

STANDARD/СТАНДАРТ

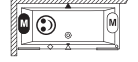

LEVÁ/LEFT/ЛЕВАЯ

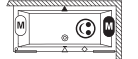

**GENOVA** BB87 180 x 80 cm / 270 l

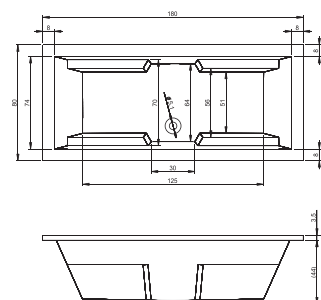

STANDARD/СТАНДАРТ

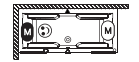

LEVÁ/LEFT/ЛЕВАЯ

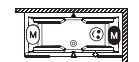

**JULIA** BA72 180 x 80 cm / 340 l

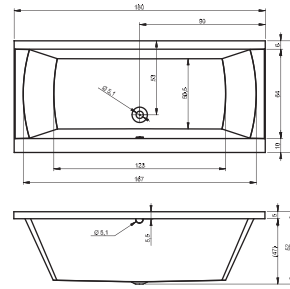

\* Při použití krycího panelu nutno zapustit sifon do podlahy  
 /When cover panel is used siphon has to be embedded in the floor  
 /При использовании покрывающей панели сифон следует утопить в пол

**LUSSO** BA77 180 x 90 cm / 330 l

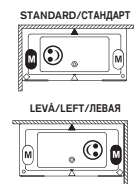
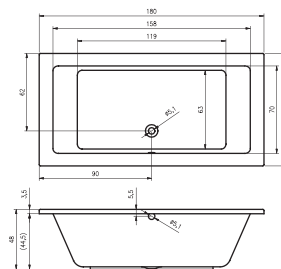

**TOFIELD** BA37 180 x 80 cm / 245 l

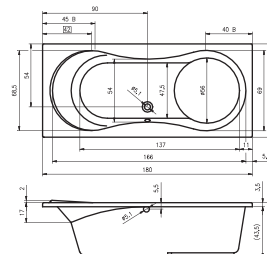

**MODENA** BA79 180 x 80 cm / 340 l

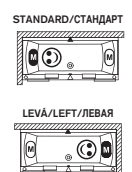
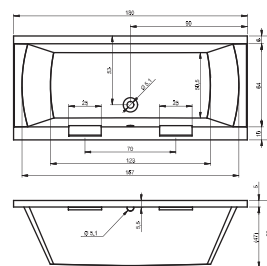

**MONTREAL** BA13 180 x 90 cm / 275 l

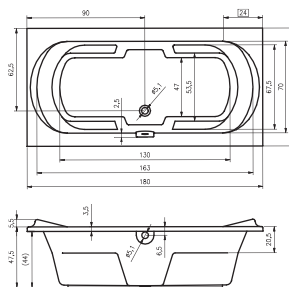

STANDARD/СТАНДАРТ

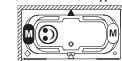

LEVÁ/LEFT/ЛЕВАЯ

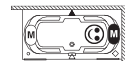

**OTTAWA** BA52 180 x 80 cm / 265 l

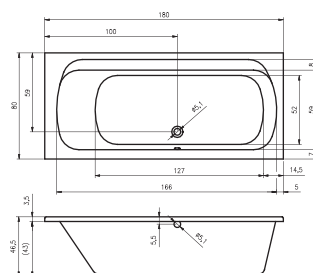

STANDARD/СТАНДАРТ

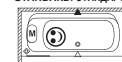

**PEGAS** BC16 180 x 80 cm / 215 l

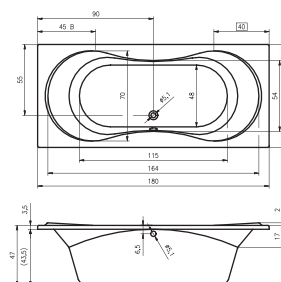

STANDARD/СТАНДАРТ

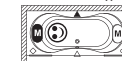

LEVÁ/LEFT/ЛЕВАЯ

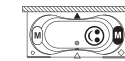

**SOBEK** BB28 180 x 115 cm / 485 l

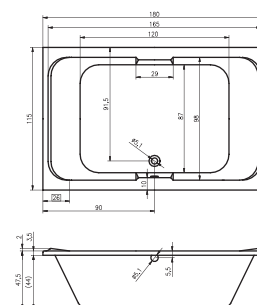

STANDARD/СТАНДАРТ



LEVÁ/LEFT/ЛЕВАЯ



**CASTELLO** BB77 180 x 120 cm / 495 l

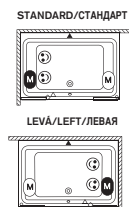
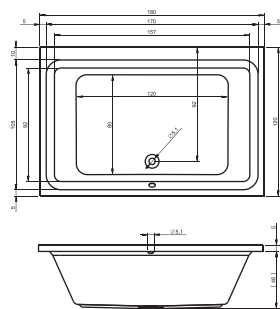

**DIMARO** BB78 180 x 90 cm / 330 l

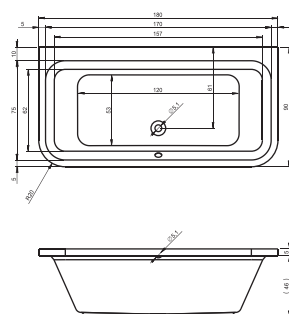

**LIVORNO** BB73 190 x 90 cm / 320 l

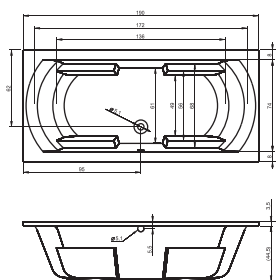

**LUSSO** BA59 190 x 80 cm / 315 l

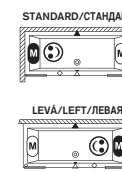
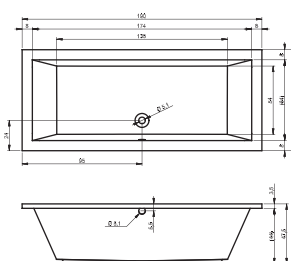

**LUSSO** BA99 190 x 90 cm / 370 l

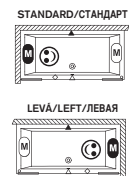
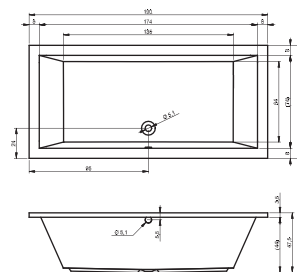

**JULIA** BA69 190 x 90 cm / 400 l

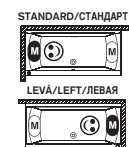
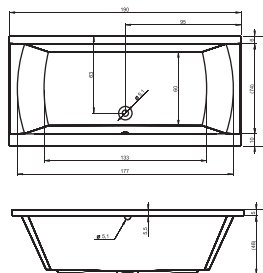

\* Při použití krycího panelu nutno zapustit sifon do podlahy  
/When cover panel is used siphon has to be embedded in the floor  
/При использовании покрывающей панели сифон следует утопить в пол

**CALGARY** BA14 190 x 90 cm / 275 l

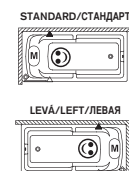
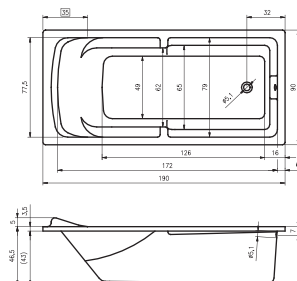

**CAROLINA** BB55 190 x 80 cm / 315 l

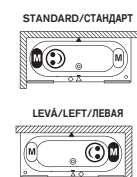
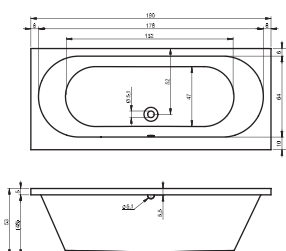

\* Při použití krycího panelu nutno zapustit sifon do podlahy  
/When cover panel is used siphon has to be embedded in the floor  
/При использовании покрывающей панели сифон следует утопить в пол



**LUSSO** BA60 200 x 90 cm / 390 l

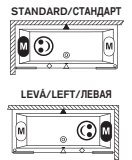
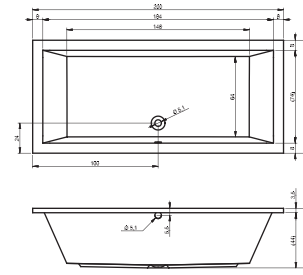

**LIMA** BB49 200 x 90 cm / 350 l

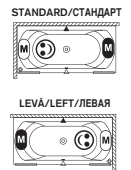
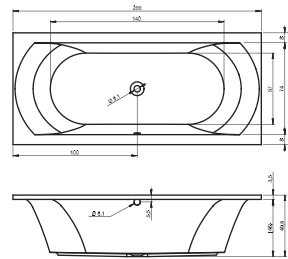

**LYRA** L BA66 / R BA65 140 x 90 cm / 200 l

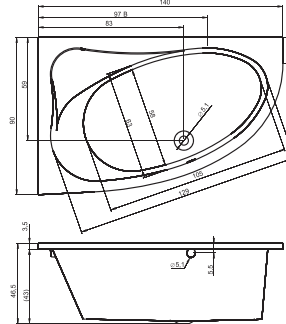

**LYRA** L BA68 / R BA67 153,5 x 100,5 cm / 230 l

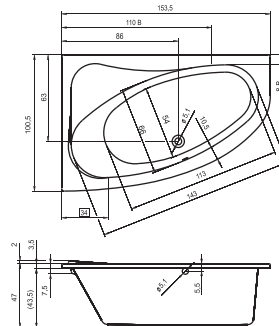

**LYRA** L BA64 / R BA63 170 x 110 cm / 280 l

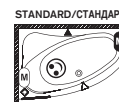
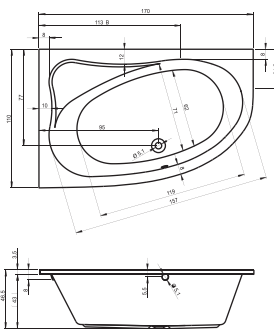

**DELTA** L BB81 / R BB80 150 x 80 cm / 190 l

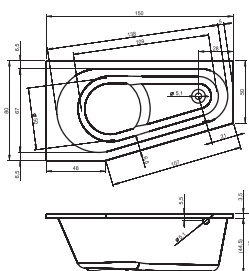

**DELTA** L BB83 / R BB82 160 x 80 cm / 210 l

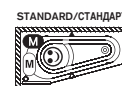
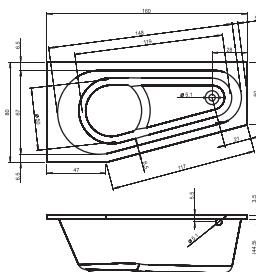

**GETA** L BA87 / R BA86 160 x 90 cm / 300 l

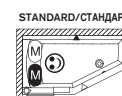
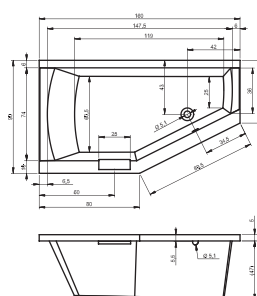



**NEO** BC34 140 x 140 cm / 315 l

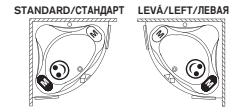
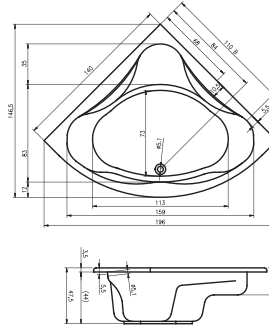

**ATLANTA** BB70 140 x 140 cm / 340 l

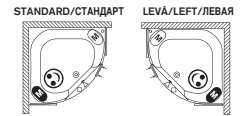
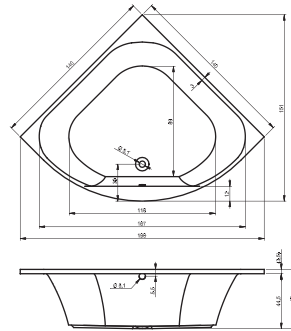

**AUSTIN** BA11 145 x 145 cm / 350 l

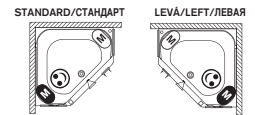
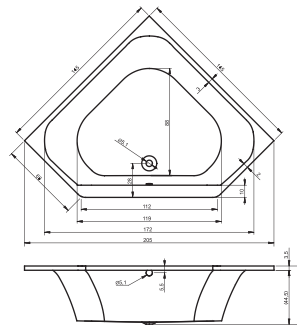

**SANTIAGO** BA06 145 x 145 cm / 330 l

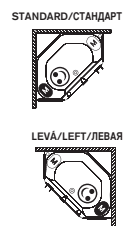
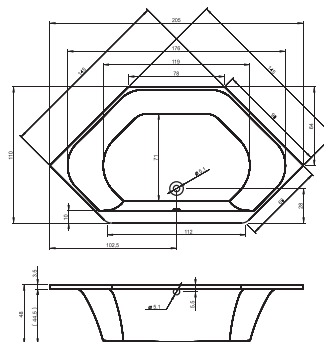

**SYDNEY** BA95 145 x 145 cm / 310 l

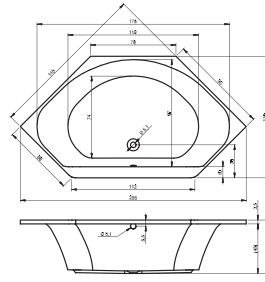

STANDARD/СТАНДАРТ

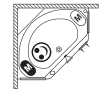

LEVÁ/ЛЕФТ/ЛЕВАЯ

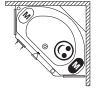

**NEO** BC35 150 x 150 cm / 365 l

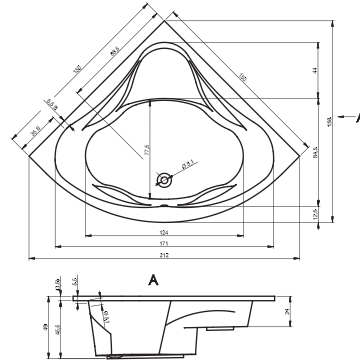

STANDARD/СТАНДАРТ



LEVÁ/ЛЕФТ/ЛЕВАЯ



**WINNIPEG** BA48 145 x 145 cm / 305 l

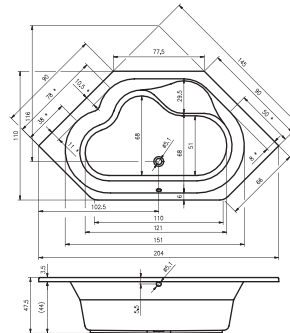

STANDARD/СТАНДАРТ



**COLORADO** BB02 180 cm / 600 l

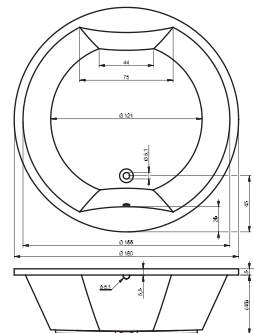

STANDARD/СТАНДАРТ



**SETH** BB22 180 x 86 cm / 245 l

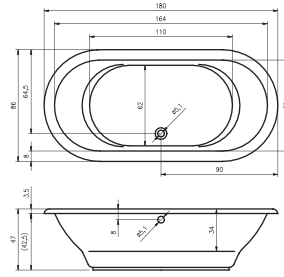

**SETH WP** BB23 180 x 86 cm / 245 l

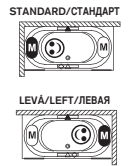
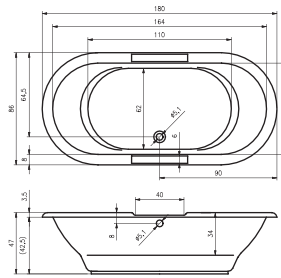

Pouze pro masážní systémy / only for whirlpools / только для массажных ван

**ALBERTA** BA31 190 x 80 cm / 245 l

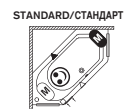
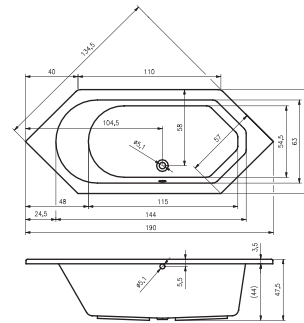

**KANSAS** BA97 190 x 90 cm / 260 l

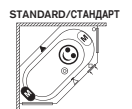
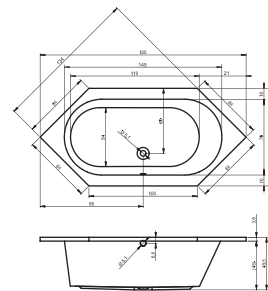

**LUGANO** BA78 190 x 90 cm / 295 l

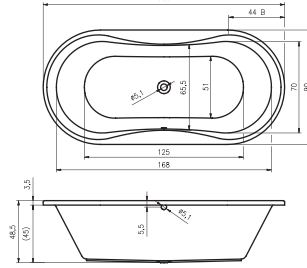

STANDARD/СТАНДАРТ

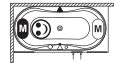

LEVÁ/LEFT/ЛЕВАЯ

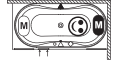

**PETIT** BZ25 120 x 70 cm / 135 l

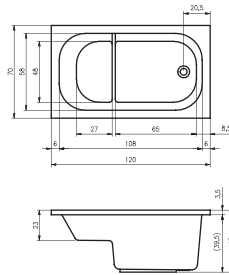

# Podpěry k vanám / Legsets / Ножки для ванн

## UNIVERSAL *POOTSET01U*

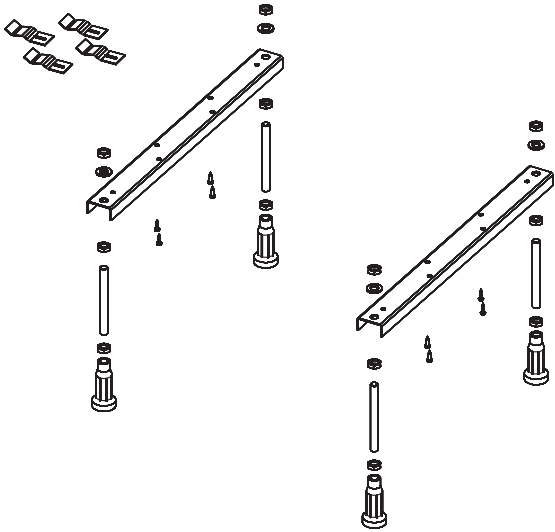

## SPECIAL PLUS *POOTSET07*

určeno pro vanu/for bathtub/для ванны:  
AUSTIN, LIMA 190, LIMA 200, NEO150, KANSAS,  
SYDNEY, SOBEK, LUSO 180x90, LUSO  
190x90, LUSO 200x90, ATLANTA, JULIA 190,  
MODENA190, LIVORNO 190, SANTIAGO,  
CASTELLO

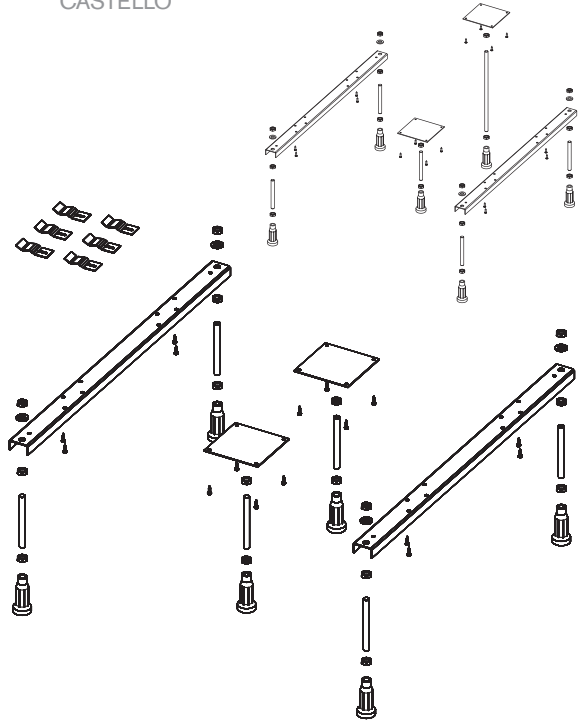

## STRONG *POOTSET08*

určeno pro vanu/for bathtub/для ванны:  
LYRA153, LYRA140, NEO140, NORA

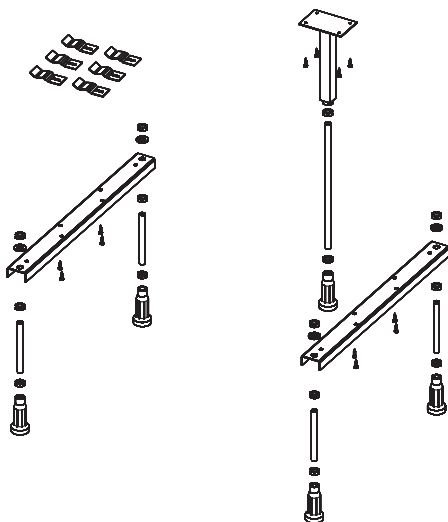

## SPECIAL 09 *POOTSET09*

určeno pro vanu/for bathtub/для ванны:  
YUKON, DOPPIO, DORADO, GETA160, 170

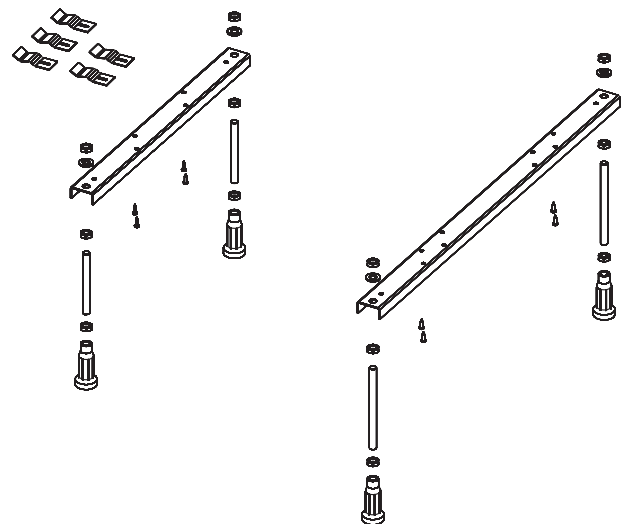

# Podpěry k vanám / Legsets / Ножки для ванн

## SPECIAL 06 POOTSET06

určeno pro vanu/for bathtub/для ванны: LUGANO, DIMARO  
volně stojící/freestanding/отдельно стоящий

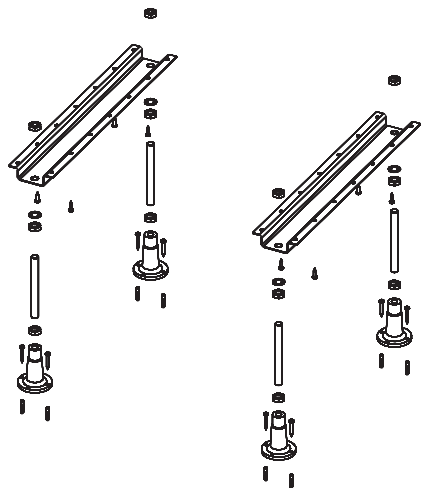

## SPECIAL 12

určeno pro vanu/for bathtub/для ванны: PETIT

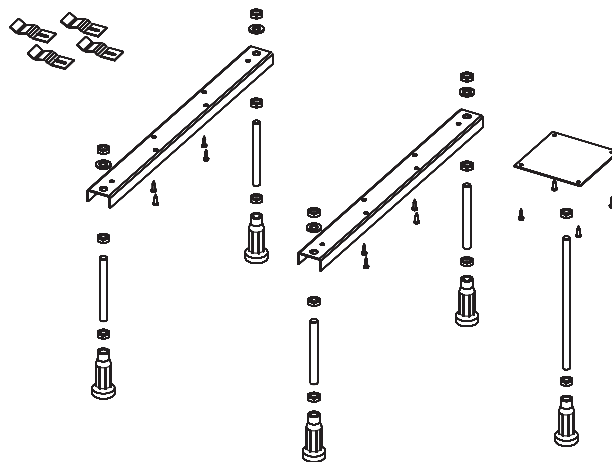

## SPECIAL 14 POOTSET14

určeno pro vanu/for bathtub/для ванны: COLORADO

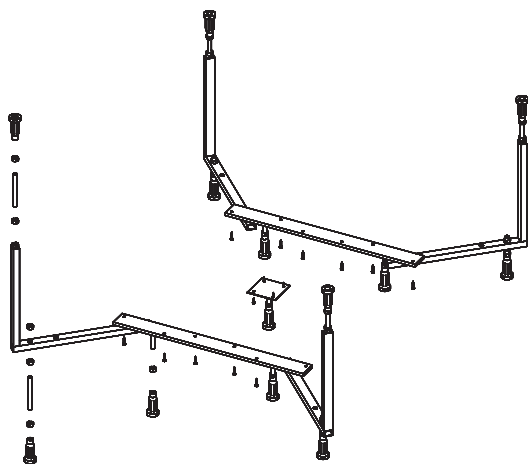

## Podpěry k panelům Legsets for panels Ножки для панелей

Není určeno pro vany  
It is not possible to use  
for the bathtubs/Невозможно  
использовать для ванн:  
COLUMBIA 140, CALGARY,  
OTTAWA, ORION, KLASIK 150,  
KLASIK 160, KLASIK 170



# HIT

masážní systém s mechanickým ovládním  
massage system with mechanical control  
массажная система с механическим управлением

## AERO 11



mechanické ovládním  
mechanical control  
механическое управление



## HYDRO 6+4+2



trysky/jets/форсунки



Hydro



Aero



Micro



Sání/Suction/Всасывание

## HYDRO 6+4+2 / AERO 11



AERO 10 - LIMA, LUGANO  
AERO 12 - DORADO, DOPIO, KANSAS  
HYDRO 4+4+2 - DORADO

AERO 19 - ATLANTA, AUSTIN, SOBEK, CASTELLO  
AERO 24 - COLORADO

# TOP

masážní systém s elektronickým ovládáním  
massage system with electronic control  
массажная система с электронным управлением

## HYDRO 6+4+2



elektronické ovládání  
electronic control  
электронное управление



E1



E2B

## HYDRO 6+4+2 / AERO 11



trysky/jets/форсунки



Hydro



Aero



Micro



Sání/Suction/Всасывание

**AERO 10** - LIMA, LUGANO  
**AERO 12** - DORADO, DOPIO, KANSAS  
**HYDRO 4+4+2** - DORADO

**AERO 19** - ATLANTA, AUSTIN, SOBEK, CASTELLO  
**AERO 24** - COLORADO

# PRO

masážní systém s elektronickým ovládním  
massage system with electronic control  
массажная система с электронным управлением

přihřev pouze s LCD displejem  
heating only with LCD display  
дополнительный обогрев только с LCD дисплеем

## AERO 11 + světlo/light/подсветка



elektronické ovládní  
electronic control  
электронное управление



E5



E7



LCD displej  
LCD display  
LCD дисплей

## HYDRO 6+4+2 + světlo/light/подсветка + čistící jednotka/clean/система дезинфекции



trysky/jets/форсунки



Hydro



Aero



Micro



Sání/Suction/Всасывание

## HYDRO 6+4+2 / AERO 11 + světlo/light/подсветка + čistící jednotka/clean/ система дезинфекции



AERO 10 - LIMA, LUGANO  
AERO 12 - DORADO, DOPIO, KANSAS  
HYDRO 4+4+2 - DORADO

AERO 19 - ATLANTA, AUSTIN, SOBEK, CASTELLO  
AERO 24 - COLORADO

## PRO Plus

masážní systém s elektronickým ovládáním  
massage system with electronic control  
массажная система с электронным управлением

přihřev pouze s LCD displejem  
heating only with LCD display  
дополнительный обогрев только с LCD дисплеем

HYDRO 8+6+2 / AERO 16 + světlo/light/подсветка  
+ čisticí jednotka/clean/  
система дезинфекции



elektronické ovládání  
electronic control  
электронное управление



E5



E7



LCD displej  
LCD display  
LCD дисплей

Pouze pro vany  
Only for the bath tubs

Только для ван

|          |  |
|----------|--|
| Carolina | 180, 190                               |
| Daytona  | 180                                    |
| Genova   | 180                                    |
| Lima     | 180, 190, 200                          |
| Livorno  | 180, 190                               |
| Lusso    | 180x80, 180x90, 190x80, 190x90, 200x90 |
| Modena   | 180, 190                               |
| Montreal | 180, 190                               |
| Julia    | 180, 190                               |

trysky/jets/форсунки



Hydro



Aero



Micro



Sání/Suction/Всасывание

**LUX** přívěv pouze s LCD displejem  
heating only with LCD display  
дополнительный обогрев только с LCD дисплеем

masážní systém s elektronickým ovládáním  
massage system with electronic control  
массажная система с электронным управлением

### HYDRO 4+4+2



HYDRO 4+4+2 + světlo/light/подсветка  
HYDRO 4+4+2 + světlo/light/подсветка  
+ čisticí jednotka/clean/система дезинфекции



HYDRO 4+4+2 / AERO 11  
HYDRO 4+4+2 / AERO 11 + světlo/light/подсветка  
HYDRO 4+4+2 / AERO 11 + světlo/light/подсветка  
+ čisticí jednotka/clean/система дезинфекции



elektronické ovládání  
electronic control  
электронное управление



E5



E7



LCD displej  
LCD display  
LCD дисплей

trysky/jets/форсунки



Maxi



Aero



Micro



Sání/Suction/Всасывание

AERO 10 - LIMA, LUGANO  
AERO 19 - ATLANTA,  
AUSTIN, SOBEK, CASTELLO

AERO 12 - DORADO,  
DOPIO, KANSAS

AERO 24 - COLORADO

HYDRO TRYSKA  
HYDRO JET  
ГИДРОФОРСУНКА



MAXI TRYSKA  
MAXI JET  
МАКСИФОРСУНКА



MINI TRYSKA  
MINI JET  
МИКРОФОРСУНКА



AERO TRYSKA  
AERO JET  
АЭРОФОРСУНКА



SÁNÍ  
SUCTION  
ВСАСЫВАНИЕ



## Podhlavníky / Headrests / Подголовники

Pevné opěrky hlavy/Fixed headrest/Прочные подголовники

**AH01**



**AH09**



Všechny podhlavníky jsou dostupné také v černém provedení/All headrests are also available in a black version/Все подголовники доступны также в черном исполнении

Podhlavníky vyrobeny z PUR  
Headrests are made of PUR/  
Подголовники изготовлены из полиуритана

Podhlavníky/ Headrest/Подголовники

**AH03**



**AH04**



**AH05**



**AH06**



**AH07**



**AH08**



**AH10**



**AH11**



**AH12**



**AH13**



**AH14**



**AH15**



**AH16**



# Doplňky / Accessories / Дополнительное оборудование

**Madlo Standard**  
**Handgrip Standard**  
**Ручка Стандарт**

Také v černé  
 Also in black  
 Также в черном исполнении



VYROBENO z PUR s výztuhou  
 Made of PUR with steel reinforcements  
 ИЗГОТОВЛЕНО ИЗ ПОЛИУРИТАНА с крепежом

**Madlo Lux (Thermae)**  
**Handgrip Lux (Thermae)**  
**Ручка Lux (Thermae)**

VYROBENO z leštěné nerez  
 Polished stainless steel  
 ИЗГОТОВЛЕНО из  
 полированной из  
 нержавеющей стали



**Madlo s napouštěním\***  
**Handgrip with filling**  
**Ручка с наполнением**

Pouze pro vany/Only for the bath tubs  
 /Толко для ван  
 DOPIO, MODENA, GETA, DAYTONA



Průtok/flow/проток 10l/min-3bar

**Držák ručníku**  
**Towel rail**  
**Держатель полотенец**

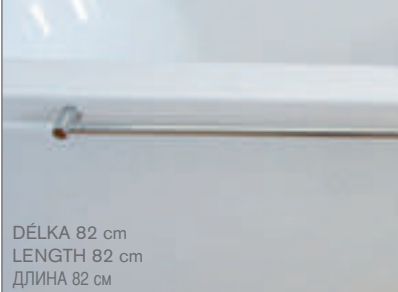

DÉLKA 82 cm  
 LENGTH 82 cm  
 ДЛИНА 82 см

**Mechanická výpust s přepadem**  
**Mechanical discharge**  
**with overflow filling**  
**Механический выпуск с перепадом**

DÉLKA 575mm, 700mm, 1000mm  
 LENGTH 575mm, 700mm, 1000mm  
 ДЛИНА 575mm, 700mm, 1000mm

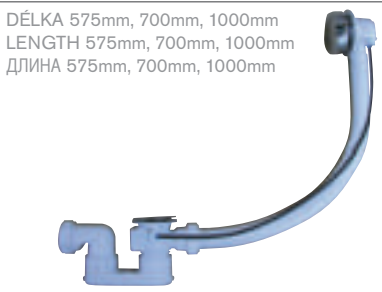

**Výpust s napouštěním přepadem**  
**Discharge with overflow filling**  
**Выпуск с наполнением и переливом**



HLOBKA/DEPTH/ГЛУБИНА 7 cm  
 Průtok/flow/проток 25l/min-3bar

**Odtoková a přepadová souprava**  
**pro přívod vody přes odpad**  
**Mechanical Discharge with waste**  
**filling from bottom – Multiplex**  
**Слив-перелив с наполнение через**  
**слив (Мульти-Слив)**

Průtok/flow/проток 23s/1min-3bar  
 Odtok/outflow/сток 51l/min



**Výpust ke sprchové vaničce**  
**Discharge for shower trays**  
**Выпуск к душевому поддону**



Ø50 mm, výška 80 mm    Ø90 mm, výška 80 mm  
 Ø50 mm, height 80 mm    Ø90 mm, height 80 mm  
 Ø50 mm, высота 80 mm    Ø90 mm, высота 80 mm

**Příhřev (pouze s LCD)**  
**Heating (only with LCD)**  
**Дополнительный обогрев (только с LCD)**

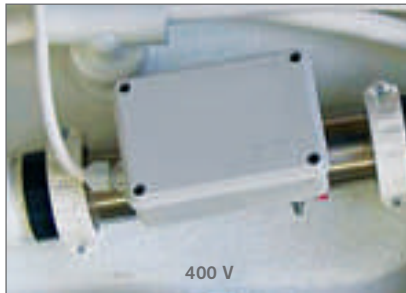

400 V

**Napouštění tryskami/**  
**jet filling/**  
**наполнение водой через форсунки**

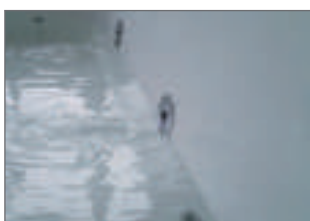

**Světlo/Light/Подсветка**  
**TOP, PRO, LUX**



**Colour terapie/Colour therapy/Хромотерапия**  
 pouze pro TOP, PRO, LUX/only for LUX and PRO/только для LUX и PRO



# Krčí panely / Cover Panels / Защитные панели

Krčí panely k rovným vanám/Cover panels for classic bathtubs/Защитные панели к прямоугольным ваннам



|  | A   | C   | B  | C  | (cm) |
|--|-----|-----|----|----|------|
|  | 140 | 140 | 70 | 70 | 57   |
|  | 150 | 150 | 75 | 75 | 57   |
|  | 160 | 160 | 80 | 80 | 57   |
|  | 170 | 170 | 90 | 90 | 57   |
|  | 175 | 175 |    |    | 57   |
|  | 180 | 180 |    |    | 57   |
|  | 190 | 190 |    |    | 57   |
|  | 200 | 200 |    |    | 57   |

Doplňk/Accessory  
Дополнительное  
оборудование

Podpěry k panelům  
Legsets for panels  
Ножки для панелей



Krčí panely k rohovým vanám/ Cover panels for corner bathtubs/Защитные панели к угловым ваннам

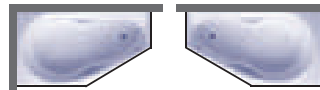
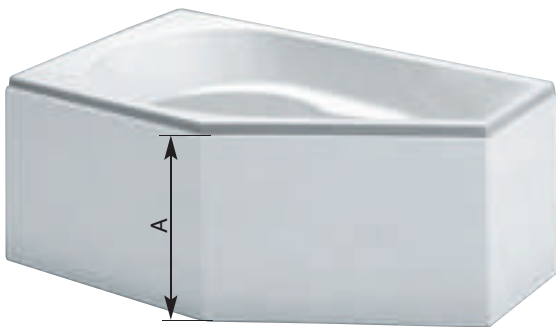

DORADO L/P



LYRA 140/150/170



WINNIPEG/AUSTIN  
/SYDNEY/SANTIAGO



LUGANO



NEO 140/150



DIMARO



ATLANTA



YUKON



NORA



LYRA 140/153



DELTA 160



GETA 160/170



# Dřevěné krycí panely Wooden cover panels Деревянные покрывающие панели

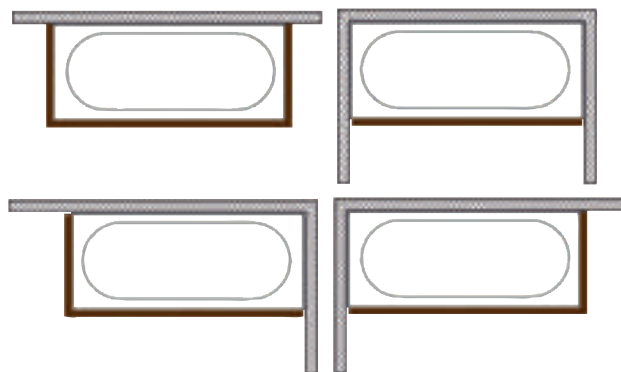

|         |  |        |
|---------|--|--------|
| P075BLK | PANEL 75 - DECOR DŘEVO ČERNÉ/DECOR WOOD BLACK  | 75x57  |
| P075DOR | PANEL 75 - DECOR DŘEVO ORME/DECOR WOOD ORME    | 75x57  |
| P083BLK | PANEL 80 - DECOR DŘEVO ČERNÉ/DECOR WOOD BLACK  | 80x57  |
| P083DOR | PANEL 80 - DECOR DŘEVO ORME/DECOR WOOD ORME    | 80x57  |
| P095BLK | PANEL 90 - DECOR DŘEVO ČERNÉ/DECOR WOOD BLACK  | 90x57  |
| P095DOR | PANEL 90 - DECOR DŘEVO ORME/DECOR WOOD ORME    | 90x57  |
| P170BLK | PANEL 170 - DECOR DŘEVO ČERNÉ/DECOR WOOD BLACK | 170x57 |
| P170DOR | PANEL 170 - DECOR DŘEVO ORME/DECOR WOOD ORME   | 170x57 |
| P180BLK | PANEL 180 - DECOR DŘEVO ČERNÉ/DECOR WOOD BLACK | 180x57 |
| P180DOR | PANEL 180 - DECOR DŘEVO ORME/DECOR WOOD ORME   | 180x57 |
| P190BLK | PANEL 190 - DECOR DŘEVO ČERNÉ/DECOR WOOD BLACK | 190x57 |
| P190DOR | PANEL 190 - DECOR DŘEVO ORME/DECOR WOOD ORME   | 190x57 |

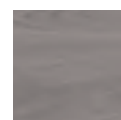

DOR orme



BLK černá

Materiál: vodotěsná dřevotříska/water - resistant chip board/водоуморная ДСМ

# RIHO CARE

## Čistící prostředky/Cleaning articles/Моющее средства



AT05003 Čistič na skleněné výrobky 500ml  
Cleaner for glass screens  
Моющее средство для стеклянных шторок



AT05004 Čistič na akrylátové výrobky 500ml  
Cleaner for acrylic products  
Моющее средство для акрилатовой продукции



AT05005 Univerzální čistič koupelen 500ml  
Universal bathroom cleaner  
Универсальное моющее средство для ванн



AT05006 Čistič na odpady 450 ml  
Cleaner waste  
Моющее средство для водостоков

## Clean systém/Clean system/Система дезинфекции



REDIS0001  
Dezinfekce – tablety  
Dezinfektion – tablets  
Дезинфекция – таблетки



REDIS0002  
Tekutina do čistící jednotky  
Fluid to the clean systém  
Дезинфекция – жидкость



Čistící jednotka  
clean system  
комплект системы дезинфекции



# Vanové zástěny / Bathtub screens / Ванные шторки

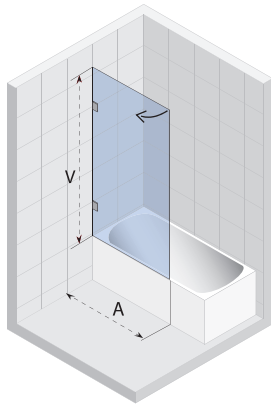

| S107    | A    | V    |
|---------|------|------|
| GC13200 | 800  | 1500 |
| GC15200 | 900  | 1500 |
| GC17200 | 1000 | 1500 |

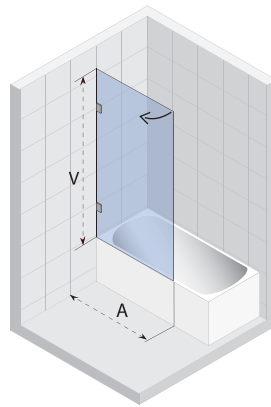

| M107      | L* | R* | A    | V    |
|-----------|----|----|------|------|
| GX010320* | 1  | 2  | 800  | 1500 |
| GX010520* | 1  | 2  | 900  | 1500 |
| GX010720* | 1  | 2  | 1000 | 1500 |

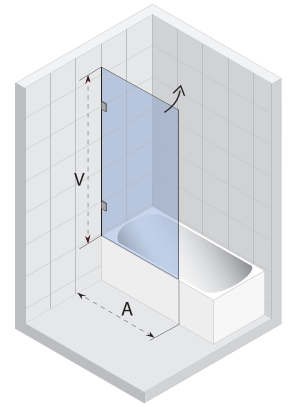

| S108    | A   | V    |
|---------|-----|------|
| GC56200 | 650 | 1500 |
| GC57200 | 750 | 1500 |
| GC58200 | 850 | 1500 |
| GC59200 | 950 | 1500 |

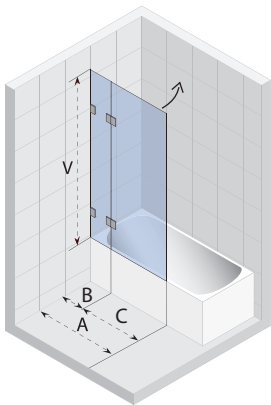

| S109    | A    | B   | C   | V    |
|---------|------|-----|-----|------|
| GC16200 | 850  | 197 | 653 | 1500 |
| GC19200 | 900  | 197 | 703 | 1500 |
| GC20200 | 950  | 297 | 653 | 1500 |
| GC21200 | 1000 | 297 | 703 | 1500 |

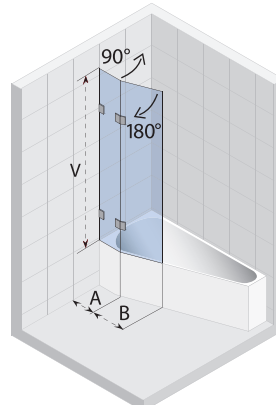

| S500                  | A   | B   | V    |
|-----------------------|-----|-----|------|
| GC60200 YUKON/NORA    | 820 | 355 | 1500 |
| GC61200 GETA 160      | 760 | 355 | 1500 |
| GC62200 GETA 170      | 860 | 355 | 1500 |
| GC63200 DELTA 150/160 | 460 | 355 | 1500 |

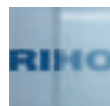
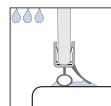
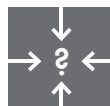

# Vanové zástěny / Bathtub screens / Ванные шторки

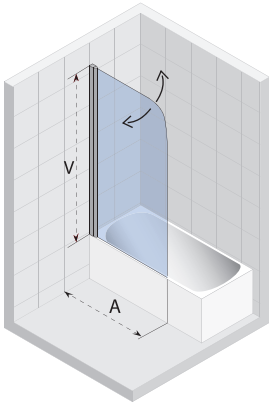

**Nautic  
N107**

|               | A   | V    |
|---------------|-----|------|
| GGT0210750800 | 750 | 1500 |
| GGT0210900800 | 900 | 1500 |

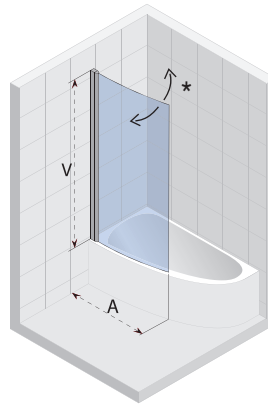

**Nautic Lyra 140,153\*,170**

| Vana          | A    | V        |
|---------------|------|----------|
| GGT5110945800 | Lyra | 890 1500 |

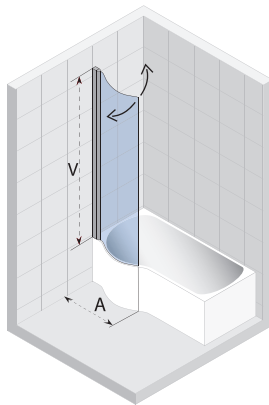

**Nautic Dorado**

| Vana          | A      | V        |
|---------------|--------|----------|
| GGT5110776800 | Dorado | 776 1500 |

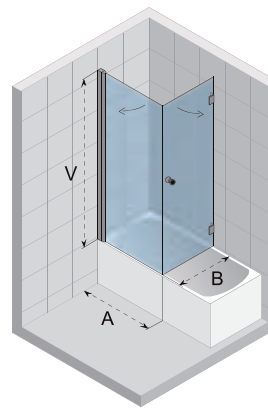

**Nautic  
N110**

|               | A      | B         | V              |
|---------------|--------|-----------|----------------|
| GHT0121650600 | 90x75  | 895 - 907 | 714 - 718 1500 |
| GHT0121700600 | 90x80  | 895 - 907 | 764 - 768 1500 |
| GHT0121800600 | 90x90  | 895 - 907 | 864 - 868 1500 |
| GHT6121526600 | Dorado | 786 - 798 | 707 - 711 1500 |

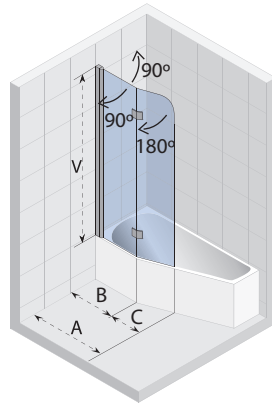
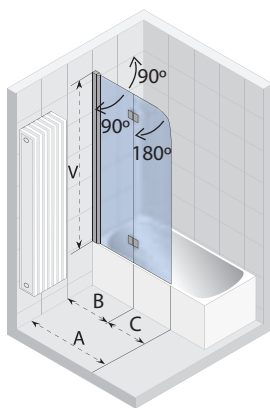

**Nautic  
N500**

|               | Vana          | A    | B   | C   | V    |
|---------------|---------------|------|-----|-----|------|
| GGT0220891800 | Delta 150/160 | 891  | 461 | 430 | 1500 |
| GGT0221000800 | L 1000        | 1000 | 570 | 430 | 1500 |
| GGT0221204800 | Geta 160      | 1204 | 774 | 430 | 1500 |
| GGT0221304800 | Geta 170      | 1304 | 874 | 430 | 1500 |
| GGT0221239800 | Yukon & Nora  | 1239 | 809 | 430 | 1500 |

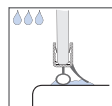

Neplatí pro Lyra 170/  
not for Lyra 170/  
не распространяется  
на шторку для ванны  
LYRA 170

\* u Lyra 153 nelze sklopit dovnitř/by bathtub Lyra 153 isn't possible recline to inside/шторку для ванны LYRA 153 нельзя открывать во внутрь





# THERMAE LINE

# LAURA

BZ28 180 x 115 cm / 485 l

## THERMAE LINE



- 2x Motor Hydro / Motor Hydro / Гидромотор
- 1x Motor Aero / Motor Aero / Аэромотор
- 6x Maxitrysky hydro / Maxi Hydro Jets / Гидро-Максифорсунки
- 12x Mikrotrysky Eyeball / Micro Jets Eyeball / Микрофорсунки Eyeball
- 19x Trysky aero / Aero Jets / Аэрофорсунки

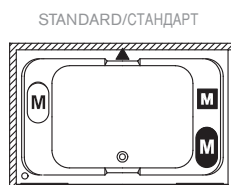
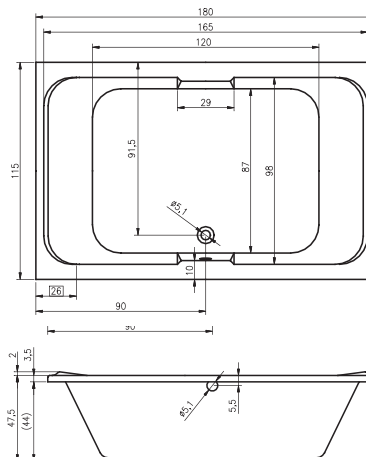

# CLAUDIA

BZ42 190 x 120 cm / 450 l

# THERMAE LINE



- 2x Motor Hydro / Motor Hydro / Гидромотор
- 1x Motor Aero / Motor Aero / Аэромотор
- 4x Maxitrysky hydro / Maxi Hydro Jets / Гидро-Максифорсунки
- 12x Mikrotrysky Eyeball / Micro Jets Eyeball / Микрофорсунки Eyeball
- 16x Trysky aero / Aero Jets / Аэрофорсунки

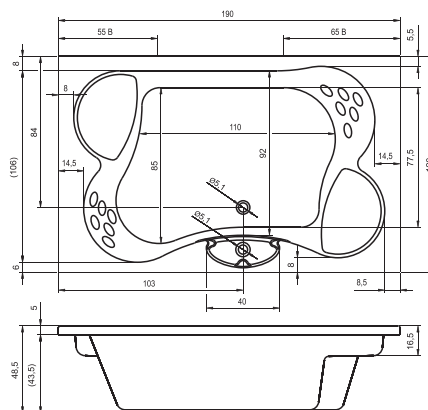
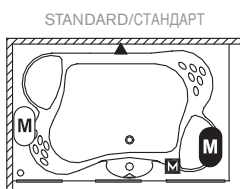

# LISA

BZ15 180 x 90 cm / 355 l

# THERMAE LINE



- 2x Motor Hydro / Motor Hydro / Гидромотор
- 1x Motor Aero / Motor Aero / Аэромотор
- 3x Hydro trysky Spa / Hydro Jets Spa / Гидрофорсунки Spa
- 3x Hydro trysky Spa rotační / Rotating Hydro Jets Spa / Микрофорсунки вращающиеся Spa
- 4x Trysky hydro / Hydro Jets / Гидрофорсунки
- 16x Trysky aero / Aero Jets / Аэрофорсунки

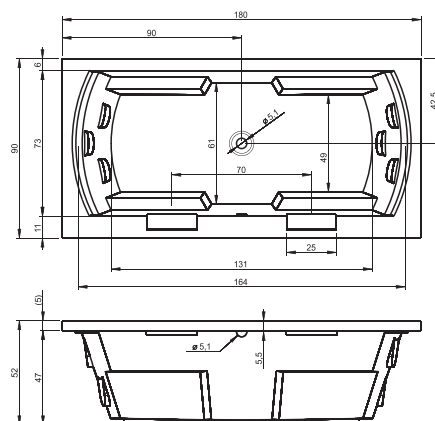

STANDARD/СТАНДАРТ

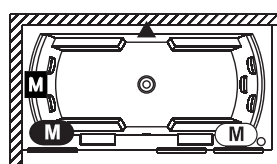

# LISETTE

# THERMAE LINE

BZ14 195 x 105 cm / 375 l



- 2x Motor Hydro / Motor Hydro / Гидромотор
- 1x Motor Aero / Motor Aero / Аэромотор
- 3x Hydro trysky Spa / Hydro Jets Spa / Гидрофорсунки Spa
- 3x Hydro trysky Spa rotační / Rotating Hydro Jets Spa / Микрофорсунки вращающиеся Spa
- 4x Trysky hydro / Hydro Jets / Гидрофорсунки
- 16x Trysky aero / Aero Jets / Аэрофорсунки

STANDARD/СТАНДАРТ

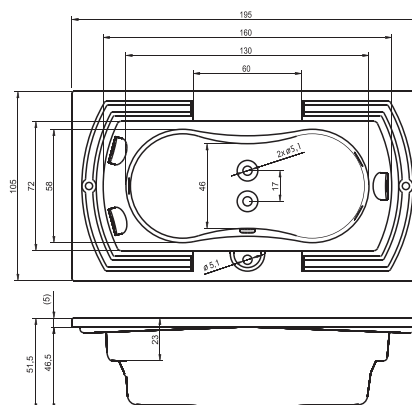
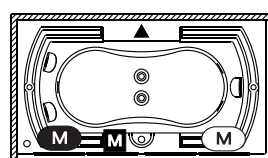

# DAPHNE

BZ40 182 x 94 cm / 270 l

# THERMAE LINE



- 2x Motor Hydro / Motor Hydro / Гидромотор
- 1x Motor Aero / Motor Aero / Аэромотор
- 6x Maxitrysky hydro / Maxi Hydro Jets / Гидро-Максифорсунки
- 8x Mikrotrysky Eyeball / Micro Jets Eyeball / Микрофорсунки Eyeball
- 16x Trysky aero / Aero Jets / Аэрофорсунки

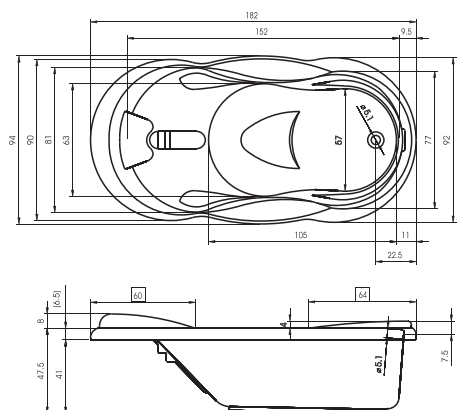

STANDARD/СТАНДАРТ

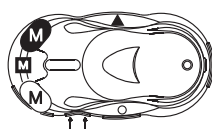

LEVÁ/LEFT/ЛЕВАЯ

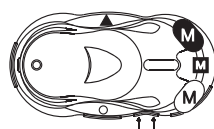

# OLIVIA

BZ77 180 x 120 cm / 495 l

# THERMAE LINE



- 2x Motor Hydro / Motor Hydro / Гидромотор
- 1x Motor Aero / Motor Aero / Аэромотор
- 6x Maxitrysky hydro / Maxi Hydro Jets / Гидро-Максифорсунки
- 14x Mikrotrysky / Micro Jets / Микрофорсунки
- 19x Trysky aero / Aero Jets / Аэрофорсунки

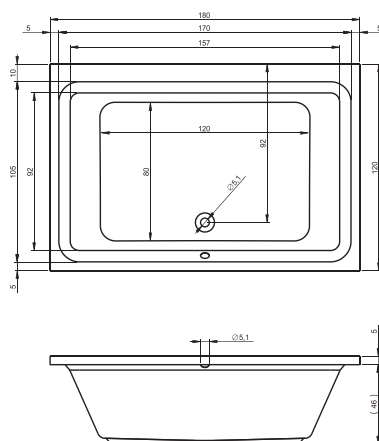
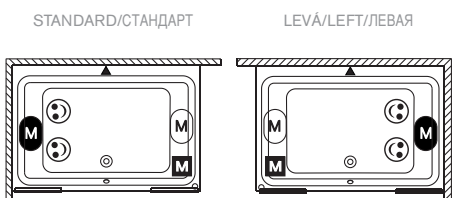

# DANA

# THERMAE LINE

BZ44 190 x 90 cm / 350 l



- 2x Motor Hydro / Motor Hydro / Гидромотор
- 1x Motor Aero / Motor Aero / Аэромотор
- 3x Hydro trysky Spa / Hydro Jets Spa / Гидрофорсунки Spa
- 3x Hydro trysky Spa rotační / Rotating Hydro Jets Spa / Микрофорсунки вращающиеся Spa
- 4x Trysky hydro / Hydro Jets / Гидрофорсунки
- 16x Trysky aero / Aero Jets / Аэрофорсунки

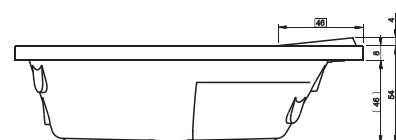
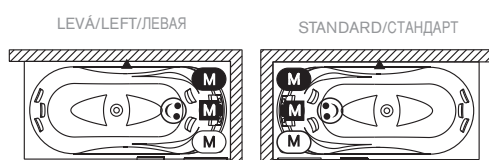
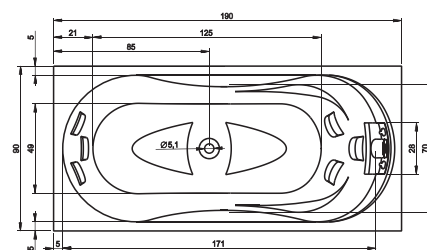

# CARMEN

BZ29 Ø180 cm / 600 l

## THERMAE LINE



- 2x Motor Hydro / Motor Hydro / Гидромотор
- 1x Motor Aero / Motor Aero / Аэромотор
- 3x Hydro trysky Spa / Hydro Jets Spa / Гидрофорсунки Spa
- 4x Hydro trysky Spa rotační / Rotating Hydro Jets Spa / Микрофорсунки вращающиеся Spa
- 24x Trysky aero / Aero Jets / Аэрофорсунки

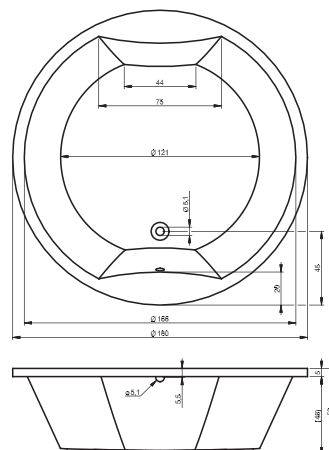
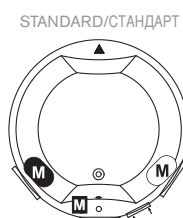

# Informace/Information/Обозначения

 Automatická čistící jednotka  
Cleansystem  
Автоматическая система дезинфекции

 Aero  
Aero system  
Аэросистема

 Pulzace  
Pulsation  
Пульсация

 Osvětlení / Colour terapie  
Light / Colour therapy  
Подсветка/Хромотерапия

 Hydro  
Hydro system  
Гидросистема

 Volba funkcí  
Function choice  
Искание функцией

 Potvrzení funkce  
Function confirmation  
Подтверждение функций

 Volba funkcí  
Function choice  
Искание функцией

 MENU  
MENU  
МЕНЮ



Hydrotryska SPA rotační  
Hydro jet SPA rotating  
Гидрофорсунка SPA вращающаяся



Aero tryska  
Aero jet  
Аэрофорсунка



Hydrotryska SPA  
Hydro jet SPA  
Гидрофорсунка SPA



Mikro tryska  
Micro jet  
Микрофорсунка



















Maxi tryska  
Maxi jet  
Максифорсунка



Hydro tryska  
Hydro jet  
Гидрофорсунка

## LCD displej / LCD display / LCD



|                 |  |  |  |  |  |  |  |  |  |  |  |  |  |  |  |  |  |
|-----------------|---|---|---|---|---|---|---|---|---|--|---|---|---|---|---|---|---|
| Carmen 180      | ○   | ■   | ■   |   |   |   |   |   |   |  | ■ 4x  | ■ 2x  | ■ 2x  | ■   | ■   | ■   | ■   |
| Claudia 190x120 | □   | ■   |   | ■   |   |   |   |   |   | ■ 2x   |   | ■ 2x  | ■   | ■   | ■   | ■   |   |
| Daphne 182x94   | ○   | ■   | ■   | ■   |   |   |   |   |   |  | ■ 1x  | ■   | ■   | ■   | ■   | ■   | ■   |
| Dana 190x90     | □   | ■   |   | ■   |   |   |   |   |   |  | ■ 1x  | ■   | ■   | ■   | ■   | ■   | ■   |
| Laura 180x115   | □   | ■   | ■   |   | ■   |   |   |   |   |  | ■ 4x  | ■ 2x  | ■ 2x  | ■   | ■   | ■   | ■   |
| Lisa 180x90     | □   | ■   | ■   |   |   | ■   |   |   |   |  | ■ 2x  | ■   | ■   | ■   | ■   | ■   | ■   |
| Lisette 195x105 | □   | ■   |   |   |   |   |   |   |   |  | ■ 2x  | ■   | ■   | ■   | ■   | ■   | ■   |
| Olivia 180x120  | □   | ■   | ■   |   | ■   |   |   |   |   |  | ■ 4x  | ■ 2x  | ■ 2x  | ■   | ■   | ■   | ■   |

# SPRCHOVÉ ZÁSTĚNY



SHOWER SCREEN / ДУШЕВЫЕ ШТОРКИ

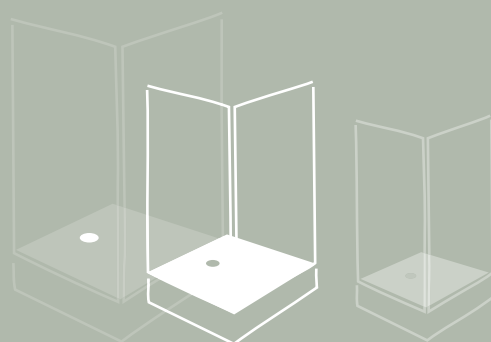

# BALTIC

NEW



Sprchové zástěny / Shower screens / Душевые шторки



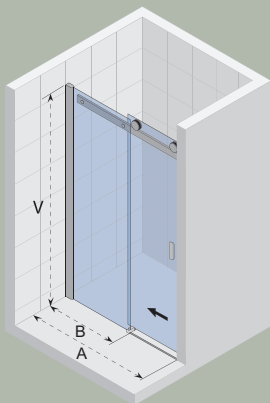

| B104      | Sprchová vanička (cm)<br>Shower tray<br>Душевой поддон |             |           |      | vstup<br>entry<br>вход |
|-----------|--|-------------|-----------|------|------------------------|
|           |  | A           | B         | V    |                        |
|           | GE0070200  | 100         | 961 - 994 | 480  |                        |
| GE0070300 | 120  | 1161 - 1194 | 580       | 2100 | 520                    |
| GE0070400 | 140  | 1361 - 1394 | 680       | 2100 | 620                    |
| GE0070500 | 160  | 1561 - 1594 | 880       | 2100 | 620                    |

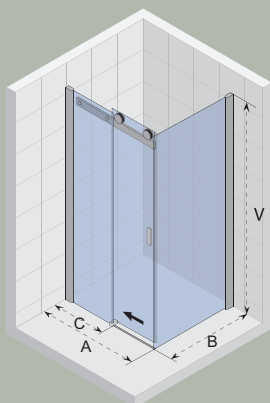

| B203      | Sprchová vanička (cm)<br>Shower tray<br>Душевой поддон |             |           |           | vstup<br>entry<br>вход |     |
|-----------|--|-------------|-----------|-----------|------------------------|-----|
|           |  | A           | B         | C         |                        | V   |
|           | GE0007200  | 100x80      | 963 - 977 | 763 - 777 |                        | 480 |
| GE0902100 | 120x80   | 1163 - 1177 | 763 - 777 | 580       | 2100                   | 510 |
| GE0902300 | 140x80   | 1363 - 1377 | 763 - 777 | 680       | 2100                   | 610 |
| GE0902500 | 160x80   | 1563 - 1577 | 763 - 777 | 880       | 2100                   | 610 |
| GE0007300 | 100x90   | 963 - 977   | 863 - 877 | 480       | 2100                   | 410 |
| GE0902200 | 120x90   | 1163 - 1177 | 863 - 877 | 580       | 2100                   | 510 |
| GE0902400 | 140x90   | 1363 - 1377 | 863 - 877 | 680       | 2100                   | 610 |
| GE0902600 | 160x90   | 1563 - 1577 | 863 - 877 | 880       | 2100                   | 610 |

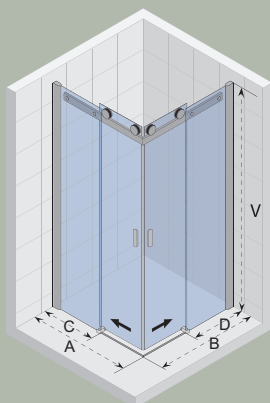

| B207      | Sprchová vanička (cm)<br>Shower tray<br>Душевой поддон |           |           |           |     | vstup<br>entry<br>вход |     |
|-----------|--|-----------|-----------|-----------|-----|------------------------|-----|
|           |  | A         | B         | C         | D   |                        | V   |
|           | GE1001600  | 80x80     | 763 - 777 | 763 - 777 | 330 |                        | 330 |
| GE1001700 | 90x80  | 863 - 877 | 763 - 777 | 430       | 330 | 2100                   | 410 |
| GE1001800 | 100x80   | 963 - 977 | 763 - 777 | 430       | 330 | 2100                   | 450 |
| GE1002000 | 90x90  | 863 - 877 | 863 - 877 | 430       | 430 | 2100                   | 450 |
| GE1002100 | 100x90   | 963 - 977 | 863 - 877 | 430       | 430 | 2100                   | 480 |
| GE1002300 | 100x100  | 963 - 977 | 963 - 977 | 430       | 430 | 2100                   | 520 |

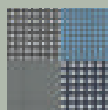
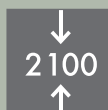
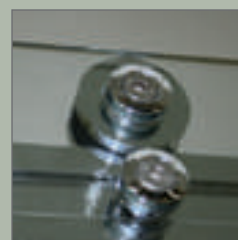

# POLAR



P201

ilustrační foto/illustration photo/иллюстративное фото



P204

ilustrační foto/illustration photo/иллюстративное фото

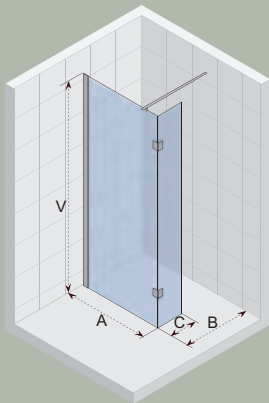

P201

Sprchová vanička (cm)  
Shower tray  
Душевой поддон

|         |                      | A           | B   | C   | V    |
|---------|----------------------|-------------|-----|-----|------|
| GP20200 | 100x80 <sup>3</sup>  | 965 - 975   | 770 | 270 | 2000 |
| GP21200 | 100x90 <sup>3</sup>  | 965 - 975   | 870 | 370 | 2000 |
| GP26200 | 100x100 <sup>3</sup> | 965 - 975   | 970 | 470 | 2000 |
| GP22200 | 120x80 <sup>3</sup>  | 1165 - 1175 | 770 | 270 | 2000 |
| GP23200 | 120x90 <sup>3</sup>  | 1165 - 1175 | 870 | 370 | 2000 |
| GP24200 | 140x90 <sup>3</sup>  | 1365 - 1375 | 870 | 370 | 2000 |
| GP25200 | 160x90 <sup>3</sup>  | 1565 - 1575 | 870 | 370 | 2000 |

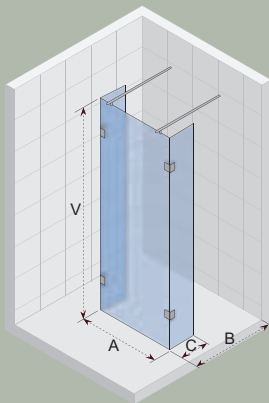
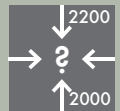

P202

Sprchová vanička (cm)  
Shower tray  
Душевой поддон

|         |                     | A    | B   | C   | V    |
|---------|---------------------|------|-----|-----|------|
| GP32200 | 120x80 <sup>2</sup> | 1160 | 770 | 270 | 2000 |
| GP33200 | 120x90 <sup>2</sup> | 1160 | 870 | 370 | 2000 |
| GP34200 | 140x90 <sup>2</sup> | 1360 | 870 | 370 | 2000 |
| GP35200 | 160x90 <sup>2</sup> | 1560 | 870 | 370 | 2000 |

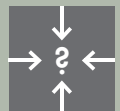

5

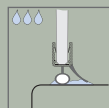
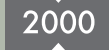

viz. str. 84/see page 84/см. стр. 84

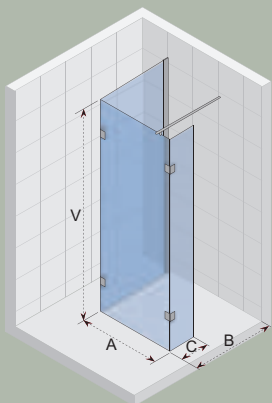

### P203

Sprchová vanička (cm)  
Shower tray  
Душевой поддон

|         |                      | A    | B         | C   | V    |
|---------|----------------------|------|-----------|-----|------|
| GP40200 | 100x80 <sup>2</sup>  | 960  | 765 - 775 | 270 | 2000 |
| GP41200 | 100x90 <sup>2</sup>  | 960  | 865 - 875 | 370 | 2000 |
| GP46200 | 100x100 <sup>2</sup> | 960  | 965 - 975 | 470 | 2000 |
| GP42200 | 120x80 <sup>2</sup>  | 1160 | 765 - 775 | 270 | 2000 |
| GP43200 | 120x90 <sup>2</sup>  | 1160 | 865 - 875 | 370 | 2000 |
| GP44200 | 140x90 <sup>2</sup>  | 1360 | 865 - 875 | 370 | 2000 |
| GP45200 | 160x90 <sup>2</sup>  | 1560 | 865 - 875 | 370 | 2000 |

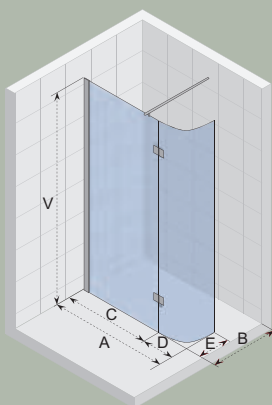
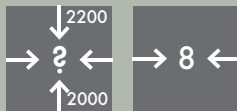

### P204

Sprchová vanička (cm)  
Shower tray  
Душевой поддон

|         |                     | A           | B   | C   | D   | E   | V    |
|---------|---------------------|-------------|-----|-----|-----|-----|------|
| GP50200 | 120x90 <sup>2</sup> | 1165 - 1175 | 870 | 893 | 277 | 375 | 2000 |



Příslušenství pro zástěny Polar/Accessories for screens Polar/Аксессуары для шторок Polar  
131604026 - profil na podlahu/glass clip/Крепление стекла

K dodání pouze za příplatek/for extra charge only/Только за дополнительную оплату

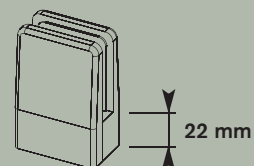

Sprchové zástěny/Shower screens/Душевые шторы

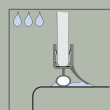
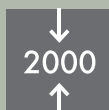

viz. str. 84/see page 84/см. стр. 84

# SCANDIC



S101



S204

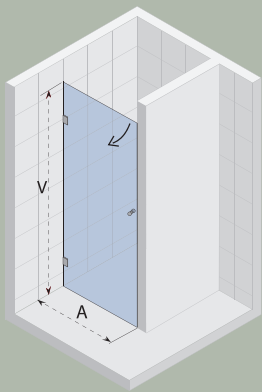

| S101    | Sprchová vanička (cm)<br>Shower tray<br>Душевой поддон |           |      |
|---------|--|-----------|------|
|         |  | A         | V    |
| GC68200 | 70 <sup>2</sup>  | 678 - 682 | 2000 |
| GC80200 | 80 <sup>2</sup>  | 778 - 782 | 2000 |
| GC01200 | 90 <sup>2</sup>  | 878 - 882 | 2000 |
| GC03200 | 100 <sup>2</sup>                                       | 978 - 982 | 2000 |

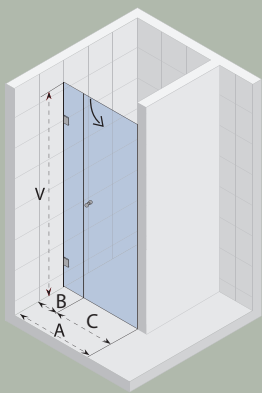

| S102    | Sprchová vanička (cm)<br>Shower tray<br>Душевой поддон |             |     |     |      |
|---------|--|-------------|-----|-----|------|
|         |  | A           | B   | C   | V    |
| GC70200 | 90 <sup>2</sup>  | 878 - 882   | 216 | 664 | 2000 |
| GC71200 | 100 <sup>2</sup>                                       | 978 - 982   | 316 | 664 | 2000 |
| GC72200 | 120 <sup>3</sup>                                       | 1178 - 1182 | 516 | 664 | 2000 |
| GC73200 | 140 <sup>3</sup>                                       | 1378 - 1382 | 716 | 664 | 2000 |
| GC74200 | 160 <sup>3</sup>                                       | 1578 - 1582 | 916 | 664 | 2000 |

Sprchové zástěny/Shower screens/Душевые шторки

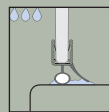
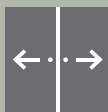
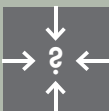
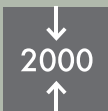
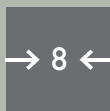

viz. str. 84/see page 84/см. стр. 84

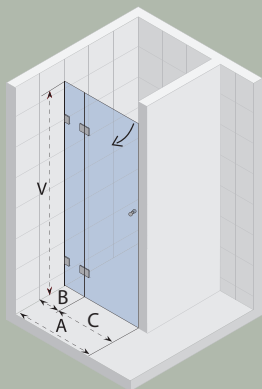

**S104** Sprchová vanička (cm)  
Shower tray  
Душевой поддон

|         |                  | A           | B   | C   | V    |
|---------|------------------|-------------|-----|-----|------|
| GC04200 | 80 <sup>2</sup>  | 778 - 782   | 197 | 583 | 2000 |
| GC05200 | 90 <sup>2</sup>  | 878 - 882   | 197 | 683 | 2000 |
| GC07200 | 100 <sup>2</sup> | 978 - 982   | 297 | 683 | 2000 |
| GC07300 | 120 <sup>2</sup> | 1178 - 1182 | 497 | 683 | 2000 |
| GC07400 | 140 <sup>2</sup> | 1378 - 1382 | 697 | 683 | 2000 |
| GC07500 | 160 <sup>2</sup> | 1578 - 1582 | 897 | 683 | 2000 |

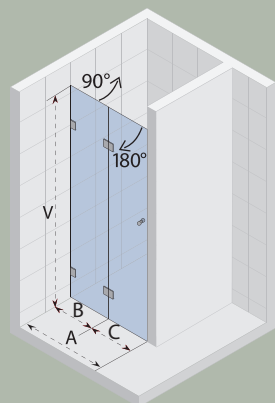

**S105** Sprchová vanička (cm)  
Shower tray  
Душевой поддон

|         |                  | A         | B   | C   | V    |
|---------|------------------|-----------|-----|-----|------|
| GC08200 | 80 <sup>2</sup>  | 778 - 782 | 384 | 396 | 2000 |
| GC09200 | 90 <sup>2</sup>  | 878 - 882 | 434 | 446 | 2000 |
| GC11200 | 100 <sup>2</sup> | 978 - 982 | 484 | 496 | 2000 |

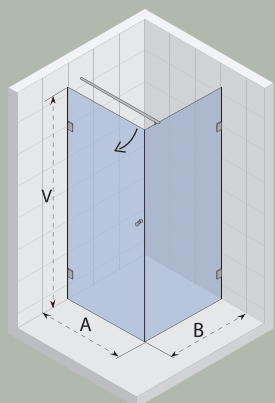

**S201** Sprchová vanička (cm)  
Shower tray  
Душевой поддон

|         |                      | A         | B         | V    |
|---------|----------------------|-----------|-----------|------|
| GC22200 | 80x80 <sup>3</sup>   | 768 - 772 | 768 - 772 | 2000 |
| GC22400 | 80x90 <sup>3</sup>   | 768 - 772 | 868 - 872 | 2000 |
| GC23100 | 90x80 <sup>3</sup>   | 868 - 872 | 768 - 772 | 2000 |
| GC23200 | 90x90 <sup>3</sup>   | 868 - 872 | 868 - 872 | 2000 |
| GC24200 | 100x80 <sup>3</sup>  | 968 - 972 | 768 - 772 | 2000 |
| GC26200 | 100x90 <sup>3</sup>  | 968 - 972 | 868 - 872 | 2000 |
| GC25200 | 100x100 <sup>3</sup> | 968 - 972 | 968 - 972 | 2000 |

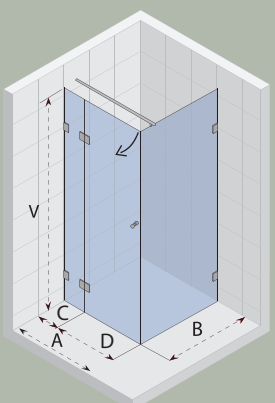

**S203** Sprchová vanička (cm)  
Shower tray  
Душевой поддон

|         |                      | A           | B         | C   | D   | V    |
|---------|----------------------|-------------|-----------|-----|-----|------|
| GC91200 | 80x80 <sup>3</sup>   | 768 - 772   | 768 - 772 | 197 | 573 | 2000 |
| GC27200 | 90x90 <sup>3</sup>   | 868 - 872   | 868 - 872 | 197 | 673 | 2000 |
| GC28200 | 100x80 <sup>3</sup>  | 968 - 972   | 768 - 772 | 297 | 673 | 2000 |
| GC90200 | 100x90 <sup>3</sup>  | 968 - 972   | 868 - 872 | 297 | 673 | 2000 |
| GC29200 | 100x100 <sup>3</sup> | 968 - 972   | 968 - 972 | 297 | 673 | 2000 |
| GC92100 | 120x80 <sup>4</sup>  | 1168 - 1172 | 768 - 772 | 497 | 673 | 2000 |
| GC92200 | 120x90 <sup>4</sup>  | 1168 - 1172 | 868 - 872 | 497 | 673 | 2000 |
| GC92400 | 140x90 <sup>5</sup>  | 1368 - 1372 | 868 - 872 | 697 | 673 | 2000 |
| GC92600 | 160x90 <sup>5</sup>  | 1568 - 1572 | 868 - 872 | 897 | 673 | 2000 |
| GC92800 | 180x90 <sup>5</sup>  | 1768 - 1772 | 868 - 872 | 897 | 873 | 2000 |

Umístění stabilizačních tyčí se liší dle rozměrů sprchové zástěny.  
Fixing rod is placed according to dimensions of the shower enclosure.  
Размещение стабилизирующего стержня зависит от размеров душевой перегородки.

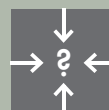
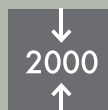
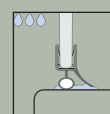
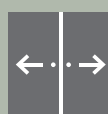

viz. str. 84/see page 84/см. стр. 84

- 2 bez stabilizační tyče/without fixing rod/без стабилизирующего стержня  
3 standardní stabilizační tyč/standard fixing rod/стабилизирующих стержня, délka 102,5 cm/length 102,5 cm/длина 102,5  
4 standardní stabilizační tyč/standard fixing rod/стабилизирующих стержня, délka 120 cm/length 120 cm/длина 120 cm, + T-kus/T-part/T-část  
5 standardní stabilizační tyč/standard fixing rod/стабилизирующих стержня, délka 160 cm/length 160 cm/длина 160 cm, + T-kus/T-part/T-část  
6 2x standardní stabilizační tyč/standard fixing rod/стабилизирующих стержня, délka 102,5 cm/length 102,5 cm/длина 102,5 cm, + T-kus/T-part/T-část

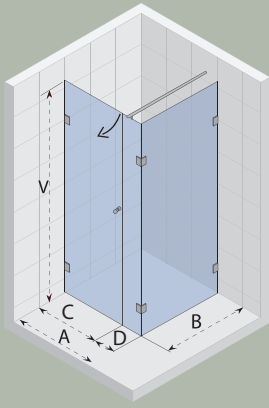

**S204** Sprchová vanička (cm)  
Shower tray  
Душевой поддон

|         |                      | A           | B         | C   | D   | V    |
|---------|----------------------|-------------|-----------|-----|-----|------|
| GC81200 | 80x80 <sup>2</sup>   | 768 - 772   | 768 - 772 | 564 | 206 | 2000 |
| GC82200 | 90x90 <sup>2</sup>   | 868 - 872   | 868 - 872 | 664 | 206 | 2000 |
| GC82700 | 100x80 <sup>2</sup>  | 968 - 972   | 768 - 772 | 664 | 306 | 2000 |
| GC83200 | 100x90 <sup>2</sup>  | 968 - 972   | 868 - 872 | 664 | 306 | 2000 |
| GC85200 | 100x100 <sup>2</sup> | 968 - 972   | 968 - 972 | 664 | 306 | 2000 |
| GC85700 | 120x80 <sup>3</sup>  | 1168 - 1172 | 768 - 772 | 664 | 506 | 2000 |
| GC84200 | 120x90 <sup>3</sup>  | 1168 - 1172 | 868 - 872 | 664 | 506 | 2000 |
| GC84700 | 140x90 <sup>3</sup>  | 1368 - 1372 | 868 - 872 | 664 | 706 | 2000 |
| GC86200 | 160x90 <sup>3</sup>  | 1568 - 1572 | 868 - 872 | 664 | 906 | 2000 |

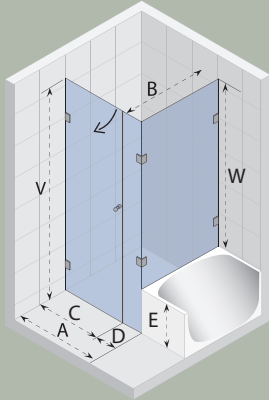

**S208** Sprchová vanička (cm)  
Shower tray  
Душевой поддон

|         |                    | A <sup>1</sup> | B         | C   | D   | E   | V    | W    |
|---------|--------------------|----------------|-----------|-----|-----|-----|------|------|
| GC33200 | 90x90 <sup>2</sup> | 878 - 882      | 868 - 872 | 664 | 216 | 400 | 2000 | 1600 |

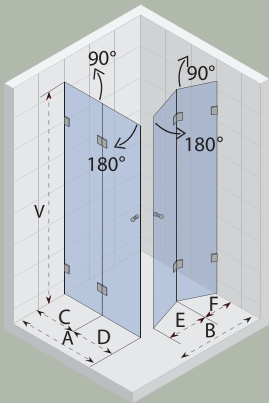

**S211** Sprchová vanička (cm)  
Shower tray  
Душевой поддон

|         |                      | A         | B         | C   | D   | E   | F   | V    |
|---------|----------------------|-----------|-----------|-----|-----|-----|-----|------|
| GC34200 | 80x80 <sup>2</sup>   | 768 - 772 | 768 - 772 | 385 | 385 | 385 | 385 | 2000 |
| GC35200 | 90x90 <sup>2</sup>   | 868 - 872 | 868 - 872 | 435 | 435 | 435 | 435 | 2000 |
| GC36200 | 100x80 <sup>2</sup>  | 968 - 972 | 768 - 772 | 485 | 485 | 385 | 385 | 2000 |
| GC38200 | 100x90 <sup>2</sup>  | 968 - 972 | 868 - 872 | 485 | 485 | 435 | 435 | 2000 |
| GC37200 | 100x100 <sup>2</sup> | 968 - 972 | 968 - 972 | 485 | 485 | 485 | 485 | 2000 |

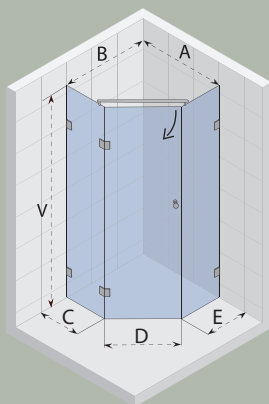

**S301** Sprchová vanička (cm)  
Shower tray  
Душевой поддон

|         |                      | A         | B         | C   | D   | E   | V    |
|---------|----------------------|-----------|-----------|-----|-----|-----|------|
| GC40200 | 90x90 <sup>4</sup>   | 868 - 872 | 868 - 872 | 382 | 690 | 382 | 2000 |
| GC42200 | 100x100 <sup>4</sup> | 968 - 972 | 968 - 972 | 482 | 690 | 482 | 2000 |

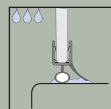
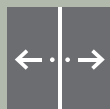
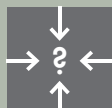
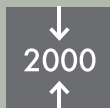
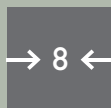

viz. str. 84/see page 84/см. стр. 84

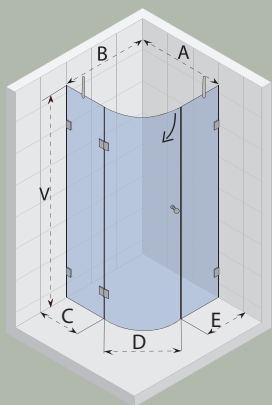

**S308** Sprchová vanička (cm)  
Shower tray  
Душевой поддон

|         |                            | A           | B           | C   | D   | E   | V    |
|---------|----------------------------|-------------|-------------|-----|-----|-----|------|
| GC44200 | 90x90; r=55 <sup>s</sup>   | 868 - 872   | 868 - 872   | 332 | 750 | 332 | 2000 |
| GC46200 | 100x100; r=55 <sup>s</sup> | 968 - 972   | 968 - 972   | 432 | 750 | 432 | 2000 |
| GC47200 | 120x120; r=55 <sup>s</sup> | 1168 - 1172 | 1168 - 1172 | 632 | 750 | 632 | 2000 |

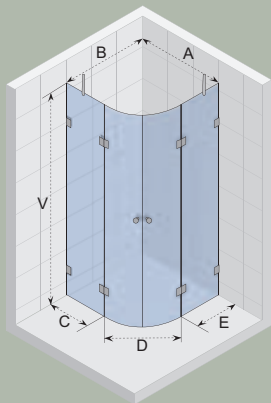

oblé sklo/bended glass/круглое остекло



**S309** Sprchová vanička (cm)  
Shower tray  
Душевой поддон

|         |                            | A           | B           | C   | D   | E   | V    |
|---------|----------------------------|-------------|-------------|-----|-----|-----|------|
| GC44300 | 90x90; r=55 <sup>s</sup>   | 868 - 872   | 868 - 872   | 332 | 750 | 332 | 2000 |
| GC46300 | 100x100; r=55 <sup>s</sup> | 968 - 972   | 968 - 972   | 432 | 750 | 432 | 2000 |
| GC47300 | 120x120; r=55 <sup>s</sup> | 1168 - 1172 | 1168 - 1172 | 632 | 750 | 632 | 2000 |

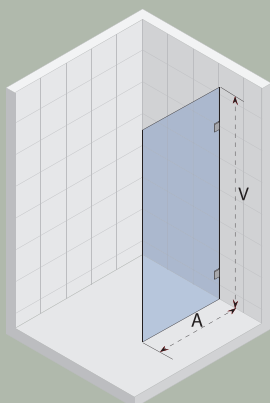

**S400** Sprchová vanička (cm)  
Shower tray  
Душевой поддон

|         |                  | A           | V    |
|---------|------------------|-------------|------|
| GC49200 | 80 <sup>2</sup>  | 748 - 752   | 2000 |
| GC50200 | 90 <sup>2</sup>  | 848 - 852   | 2000 |
| GC52200 | 100 <sup>2</sup> | 948 - 952   | 2000 |
| GC51200 | 120 <sup>3</sup> | 1148 - 1152 | 2000 |
| GC53200 | 140 <sup>3</sup> | 1348 - 1352 | 2000 |
| GC54200 | 160 <sup>3</sup> | 1548 - 1552 | 2000 |

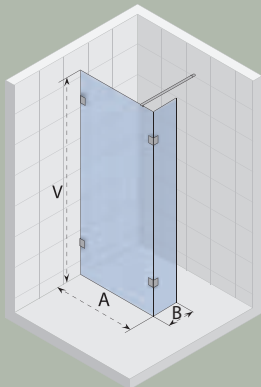

**S402** Sprchová vanička (cm)  
Shower tray  
Душевой поддон

|         |                  | A           | B   | V    |
|---------|------------------|-------------|-----|------|
| GC75200 | 100 <sup>3</sup> | 968 - 972   | 292 | 2000 |
| GC76200 | 100 <sup>3</sup> | 1068 - 1072 | 292 | 2000 |
| GC77200 | 120 <sup>3</sup> | 1168 - 1172 | 292 | 2000 |
| GC78200 | 140 <sup>3</sup> | 1368 - 1372 | 292 | 2000 |
| GC79200 | 160 <sup>3</sup> | 1568 - 1572 | 292 | 2000 |

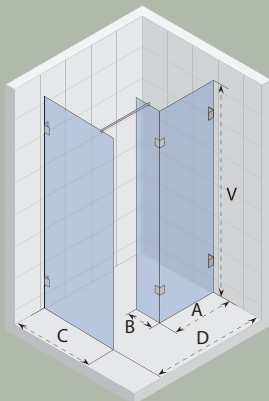

**S405**

|         | A           | B   | C         | D        | V    |
|---------|-------------|-----|-----------|----------|------|
| GC94200 | 768 - 772   | 292 | 848 - 852 | max 1770 | 2000 |
| GC95200 | 868 - 872   | 292 | 848 - 852 | max 1870 | 2000 |
| GC96200 | 968 - 972   | 292 | 848 - 852 | max 1970 | 2000 |
| GC97200 | 1068 - 1072 | 292 | 848 - 852 | max 2070 | 2000 |

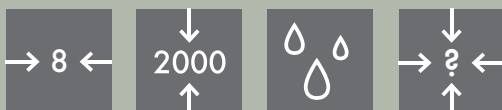

viz. str. 84/see page 84/см. стр. 84

# SCANDIC WALL



W203



W400

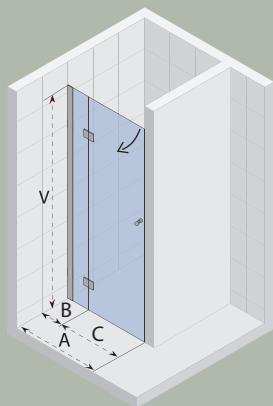

**W104** Sprchová vanička (cm)  
Shower tray  
Душевой поддон

|         |      | A           | B   | C   | V    |
|---------|------|-------------|-----|-----|------|
| GW05200 | 90°  | 875 - 885   | 197 | 683 | 2000 |
| GW11200 | 100° | 975 - 985   | 297 | 683 | 2000 |
| GW12200 | 120° | 1175 - 1185 | 497 | 683 | 2000 |
| GW13200 | 140° | 1375 - 1385 | 697 | 683 | 2000 |
| GW14200 | 160° | 1575 - 1585 | 897 | 683 | 2000 |

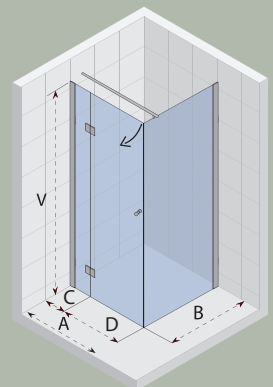

**W203** Sprchová vanička (cm)  
Shower tray  
Душевой поддон

|         |          | A           | B         | C   | D   | V    |
|---------|----------|-------------|-----------|-----|-----|------|
| GW27200 | 90x90°   | 865 - 875   | 865 - 875 | 197 | 673 | 2000 |
| GW28200 | 100x80°  | 965 - 975   | 765 - 775 | 297 | 673 | 2000 |
| GW90200 | 100x90°  | 965 - 975   | 865 - 875 | 297 | 673 | 2000 |
| GW29200 | 100x100° | 965 - 975   | 965 - 975 | 297 | 673 | 2000 |
| GW92200 | 120x90°  | 1165 - 1175 | 865 - 875 | 497 | 673 | 2000 |

Umístění stabilizačních tyčí se liší dle rozměrů sprchové zástěny.  
Fixing rod is placed according to dimensions of the shower enclosure.  
Размещение стабилизирующего стержня зависит от размеров душевой перегородки.

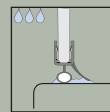
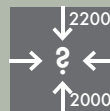
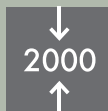

viz. str. 84/see page 84/см. стр. 84

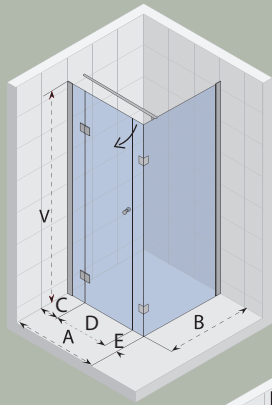

### W205

Sprchová vanička (cm)  
Shower tray  
Душевой поддон

|                      |                     | A           | B         | C   | D   | E   | V    |
|----------------------|---------------------|-------------|-----------|-----|-----|-----|------|
| GW30200              | 120x80 <sup>6</sup> | 1165 - 1175 | 765 - 775 | 230 | 710 | 230 | 2000 |
| GW31200              | 120x90 <sup>6</sup> | 1165 - 1175 | 865 - 875 | 230 | 710 | 230 | 2000 |
| GW32200 <sup>7</sup> | 140x90 <sup>7</sup> | 1365 - 1375 | 865 - 875 | 330 | 710 | 330 | 2000 |
| GW33200 <sup>7</sup> | 160x90 <sup>7</sup> | 1565 - 1575 | 865 - 875 | 430 | 710 | 430 | 2000 |

Umístění stabilizačních tyčí se liší dle rozměrů sprchové zástěny.

Fixing rod is placed according to dimensions of the shower enclosure.

Размещение стабилизирующего стержня зависит от размеров душевой перегородки.

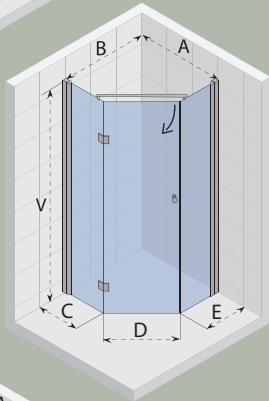

### W301

Sprchová vanička (cm)  
Shower tray  
Душевой поддон

|         |                      | A         | B         | C   | D   | E   | V    |
|---------|----------------------|-----------|-----------|-----|-----|-----|------|
| GW40200 | 90x90 <sup>4</sup>   | 865 - 875 | 865 - 875 | 382 | 690 | 382 | 2000 |
| GW42200 | 100x100 <sup>4</sup> | 965 - 975 | 965 - 975 | 482 | 690 | 482 | 2000 |

oblé sklo/bended glass/круглое остекло

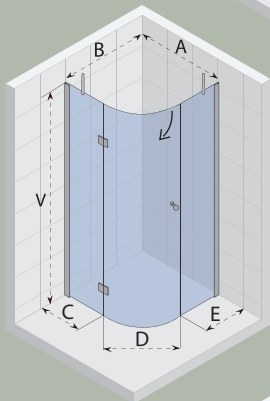

### W308

Sprchová vanička (cm)  
Shower tray  
Душевой поддон

|         |                            | A           | B           | C   | D   | E   | V    |
|---------|----------------------------|-------------|-------------|-----|-----|-----|------|
| GW44200 | 90x90; r=55 <sup>5</sup>   | 865 - 875   | 865 - 875   | 332 | 750 | 332 | 2000 |
| GW46200 | 100x100; r=55 <sup>5</sup> | 965 - 975   | 965 - 975   | 432 | 750 | 432 | 2000 |
| GW47200 | 120x120; r=55 <sup>5</sup> | 1165 - 1175 | 1165 - 1175 | 632 | 750 | 632 | 2000 |



oblé sklo/bended glass/круглое остекло

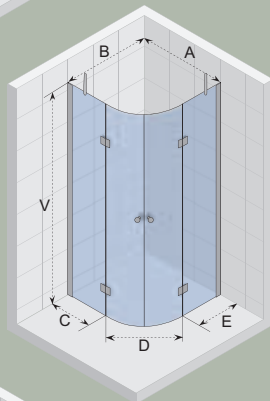

### W309

Sprchová vanička (cm)  
Shower tray  
Душевой поддон

|         |                            | A           | B           | C   | D   | E   | V    |
|---------|----------------------------|-------------|-------------|-----|-----|-----|------|
| GW44300 | 90x90; r=55 <sup>5</sup>   | 865 - 875   | 865 - 875   | 332 | 750 | 332 | 2000 |
| GW46300 | 100x100; r=55 <sup>5</sup> | 965 - 975   | 965 - 975   | 432 | 750 | 432 | 2000 |
| GW47300 | 120x120; r=55 <sup>5</sup> | 1165 - 1175 | 1165 - 1175 | 632 | 750 | 632 | 2000 |

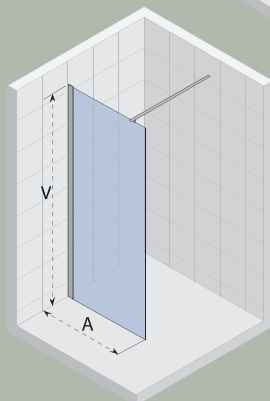

### W400

Sprchová vanička (cm)  
Shower tray  
Душевой поддон

|         |                  | A           | V    |
|---------|------------------|-------------|------|
| GW49200 | 80 <sup>2</sup>  | 745 - 755   | 2000 |
| GW50200 | 90 <sup>2</sup>  | 845 - 855   | 2000 |
| GW52200 | 100 <sup>2</sup> | 945 - 955   | 2000 |
| GW51200 | 120 <sup>3</sup> | 1145 - 1155 | 2000 |

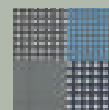
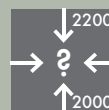
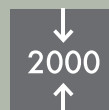
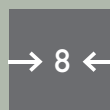
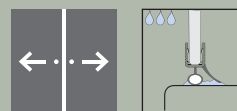

viz. str. 84/see page 84/см. стр. 84

2 bez stabilizační tyče/without fixing rod/без стабилизирующего стержня

3 standardní stabilizační tyč/standard fixing rod//стабилизирующих стержня, délka 102,5 cm/length 102,5 cm/длина 102,5 cm

4 stabilizační tyč k zástěně/fixing rod for shower screen/стабилизирующий стержень к перегородке W301

5 2x stabilizační tyč 45°/2x fixing rod 45°/стабилизирующих стержня 45°

6 standardní stabilizační tyč/standard fixing rod//стабилизирующих стержня, délka 120 cm/length 120 cm/длина 120 cm

7 standardní stabilizační tyč/standard fixing rod//стабилизирующих стержня, délka 160 cm/length 160 cm/длина 160 cm, + T-kus/T-part/Т-часть

# SCANDIC LIFT - Mistral



M201



M203

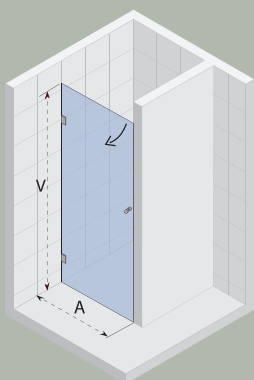

M101

Sprchová vanička (cm)

Shower tray  
Душевой поддон

|           | *L | *R |      | A         | V    |
|-----------|----|----|------|-----------|------|
| GX060820* | 1  | 2  | 70°  | 678 - 682 | 2000 |
| GX080020* | 1  | 2  | 80°  | 778 - 782 | 2000 |
| GX000120* | 1  | 2  | 90°  | 878 - 882 | 2000 |
| GX000320* | 1  | 2  | 100° | 978 - 982 | 2000 |

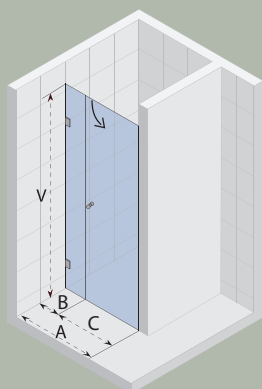

M102

Sprchová vanička (cm)

Shower tray  
Душевой поддон

|           | L* | R* |      | A           | B   | C   | V    |
|-----------|----|----|------|-------------|-----|-----|------|
| GX070200* | 1  | 2  | 90°  | 878 - 882   | 216 | 664 | 2000 |
| GX071200* | 1  | 2  | 100° | 978 - 982   | 316 | 664 | 2000 |
| GX072200* | 1  | 2  | 120° | 1178 - 1182 | 516 | 664 | 2000 |
| GX073200* | 1  | 2  | 140° | 1378 - 1382 | 716 | 664 | 2000 |
| GX074200* | 1  | 2  | 160° | 1578 - 1582 | 916 | 664 | 2000 |

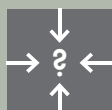
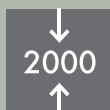
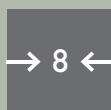
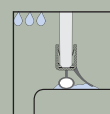
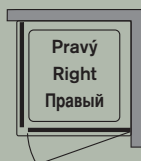

viz. str. 84/see page 84/см. стр. 84

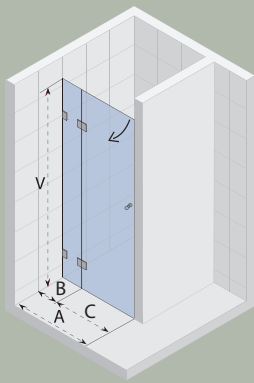

### M104

Sprchová vanička (cm)  
Shower tray  
Душевой поддон

|           | *L | *R |      | A           | B   | C   | V    |
|-----------|----|----|------|-------------|-----|-----|------|
| GX004020* | 1  | 2  | 80°  | 768 - 772   | 197 | 573 | 2000 |
| GX008020* | 1  | 2  | 90°  | 878 - 882   | 197 | 683 | 2000 |
| GX007020* | 1  | 2  | 100° | 978 - 982   | 297 | 683 | 2000 |
| GX007030* | 1  | 2  | 120° | 1178 - 1182 | 497 | 683 | 2000 |
| GX007040* | 1  | 2  | 140° | 1378 - 1382 | 697 | 683 | 2000 |
| GX007050* | 1  | 2  | 160° | 1578 - 1582 | 897 | 683 | 2000 |

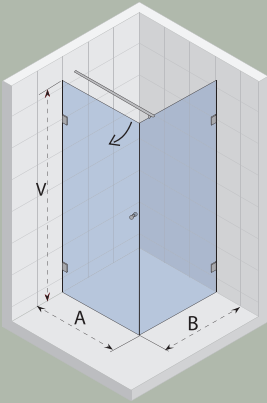
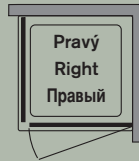
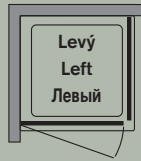

### M201

Sprchová vanička (cm)  
Shower tray  
Душевой поддон

|           | *L | *R |          | A         | B         | V    |
|-----------|----|----|----------|-----------|-----------|------|
| GX020220* | 1  | 2  | 80x80°   | 768 - 772 | 768 - 772 | 2000 |
| GX020240* | 1  | 2  | 80x90°   | 768 - 772 | 868 - 872 | 2000 |
| GX020310* | 1  | 2  | 90x80°   | 868 - 872 | 768 - 772 | 2000 |
| GX020320* | 1  | 2  | 90x90°   | 868 - 872 | 868 - 872 | 2000 |
| GX020420* | 1  | 2  | 100x80°  | 968 - 972 | 768 - 772 | 2000 |
| GX020620* | 1  | 2  | 100x90°  | 968 - 972 | 868 - 872 | 2000 |
| GX020520* | 1  | 2  | 100x100° | 968 - 972 | 968 - 972 | 2000 |

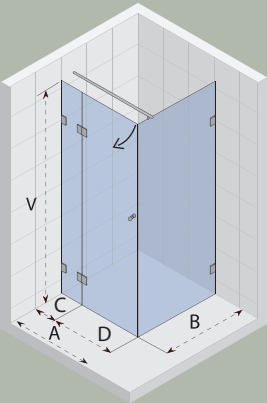
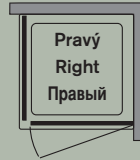
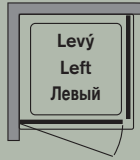

### M203

Sprchová vanička (cm)  
Shower tray  
Душевой поддон

|           | *L | *R |          | A           | B         | C   | D   | V    |
|-----------|----|----|----------|-------------|-----------|-----|-----|------|
| GX000420* | 1  | 2  | 80x80°   | 768 - 772   | 768 - 772 | 197 | 573 | 2000 |
| GX000520* | 1  | 2  | 90x90°   | 868 - 872   | 868 - 872 | 197 | 673 | 2000 |
| GX000720* | 1  | 2  | 100x80°  | 968 - 972   | 768 - 772 | 297 | 673 | 2000 |
| GX000730* | 1  | 2  | 100x90°  | 968 - 972   | 868 - 872 | 297 | 673 | 2000 |
| GX000740* | 1  | 2  | 100x100° | 968 - 972   | 968 - 972 | 297 | 673 | 2000 |
| GX090210* | 1  | 2  | 120x80°  | 1168 - 1172 | 768 - 772 | 497 | 673 | 2000 |
| GX090220* | 1  | 2  | 120x90°  | 1168 - 1172 | 868 - 872 | 497 | 673 | 2000 |
| GX090240* | 1  | 2  | 140x90°  | 1368 - 1372 | 868 - 872 | 697 | 673 | 2000 |
| GX090260* | 1  | 2  | 160x90°  | 1568 - 1572 | 868 - 872 | 897 | 673 | 2000 |
| GX090280* | 1  | 2  | 180x90°  | 1768 - 1772 | 868 - 872 | 897 | 873 | 2000 |

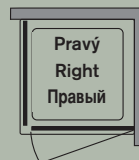

Umístění stabilizačních tyčí se liší dle rozměrů sprchové zástěny.  
Fixing rod is placed according to dimensions of the shower enclosure.  
Размещение стабилизирующего стержня зависит от размеров душевой перегородки.

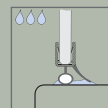
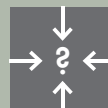
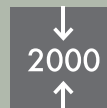

- 2 bez stabilizační tyče/without fixing rod/без стабилизирующего стержня  
3 standardní stabilizační tyč/standard fixing rod//стабилизирующих стержня, délka 102,5 cm/length 102,5 cm/длина 102,5 cm  
4 standardní stabilizační tyč/standard fixing rod//стабилизирующих стержня, délka 120 cm/length 120 cm/длина 120 cm, + T-kus/T-part/Т-часть  
5 standardní stabilizační tyč/standard fixing rod//стабилизирующих стержня, délka 160 cm/length 160 cm/длина 160 cm, + T-kus/T-part/Т-часть  
6 2x standardní stabilizační tyč/standard fixing rod//стабилизирующих стержня, délka 102,5 cm/length 102,5 cm/длина 102,5 cm, + T-kus/T-part/Т-часть

viz. str. 84/see page 84/см. стр. 84

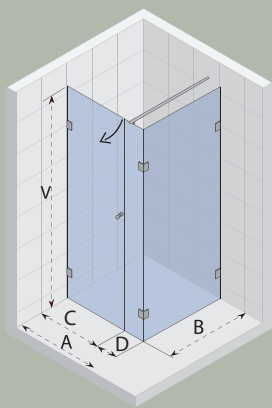

### M204

|           |    |    | Sprchová vanička (cm)<br>Shower tray<br>Душевой поддон |             |           |     |     |      |
|-----------|----|----|--|-------------|-----------|-----|-----|------|
|           | *L | *R | A  | B           | C         | D   | V   |      |
| GX080120* | 1  | 2  | 80x80 <sup>2</sup>                                     | 768 - 772   | 768 - 772 | 564 | 206 | 2000 |
| GX080220* | 1  | 2  | 90x90 <sup>2</sup>                                     | 868 - 872   | 868 - 872 | 664 | 206 | 2000 |
| GX080270* | 1  | 2  | 100x80 <sup>2</sup>                                    | 968 - 972   | 768 - 772 | 664 | 306 | 2000 |
| GX080320* | 1  | 2  | 100x90 <sup>2</sup>                                    | 968 - 972   | 868 - 872 | 664 | 306 | 2000 |
| GX080520* | 1  | 2  | 100x100 <sup>2</sup>                                   | 968 - 972   | 968 - 972 | 664 | 306 | 2000 |
| GX080570* | 1  | 2  | 120x80 <sup>3</sup>                                    | 1168 - 1172 | 768 - 772 | 664 | 506 | 2000 |
| GX080420* | 1  | 2  | 120x90 <sup>3</sup>                                    | 1168 - 1172 | 868 - 872 | 664 | 506 | 2000 |
| GX080470* | 1  | 2  | 140x90 <sup>3</sup>                                    | 1368 - 1372 | 868 - 872 | 664 | 706 | 2000 |
| GX080620* | 1  | 2  | 160x90 <sup>3</sup>                                    | 1568 - 1572 | 868 - 872 | 664 | 906 | 2000 |

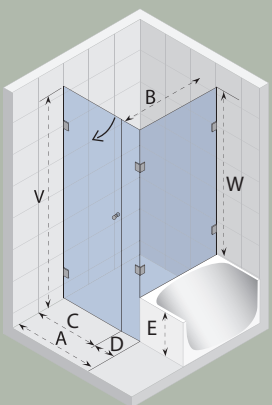
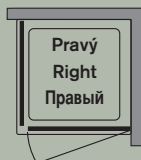

### M208

|           |    |    | Sprchová vanička (cm)<br>Shower tray<br>Душевой поддон |           |           |     |     |     |      |      |
|-----------|----|----|--|-----------|-----------|-----|-----|-----|------|------|
|           | L* | R* | A <sup>1</sup>   | B         | C         | D   | E   | V   | W    |      |
| GX030320* | 1  | 2  | 90x90 <sup>2</sup>                                     | 878 - 882 | 868 - 872 | 664 | 216 | 400 | 2000 | 1600 |

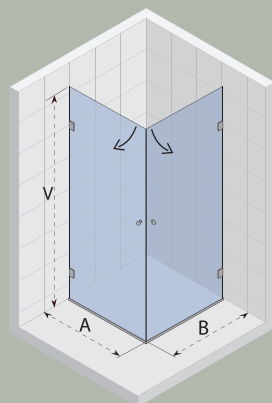

### M209

|           | Sprchová vanička (cm)<br>Shower tray<br>Душевой поддон |           |           |      |
|-----------|--|-----------|-----------|------|
|           | A  | B         | V         |      |
| GX1202200 | 80x80 <sup>2</sup>                                     | 768 - 772 | 768 - 772 | 2000 |
| GX1207200 | 90x80 <sup>2</sup>                                     | 868 - 872 | 768 - 772 | 2000 |
| GX1203200 | 90x90 <sup>2</sup>                                     | 868 - 872 | 868 - 872 | 2000 |
| GX1204200 | 100x80 <sup>2</sup>                                    | 968 - 972 | 768 - 772 | 2000 |
| GX1206200 | 100x90 <sup>2</sup>                                    | 968 - 972 | 868 - 872 | 2000 |
| GX1205200 | 100x100 <sup>2</sup>                                   | 968 - 972 | 968 - 972 | 2000 |

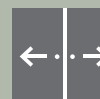

viz. str. 84/see page 84/см. стр. 84

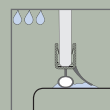
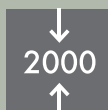
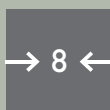

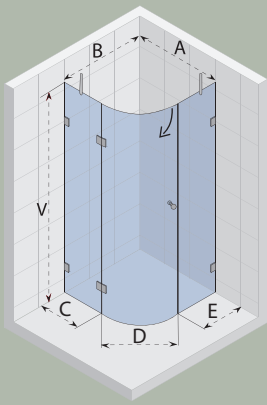

### M308

|           |     | Sprchová vanička (cm)<br>Shower tray<br>Душевой поддон |             | A           | B   | C   | D   | E    | V |
|-----------|-----|--|-------------|-------------|-----|-----|-----|------|---|
| GX040420* | 1 2 | 90x90; r=55 <sup>7</sup>                               | 868 - 872   | 868 - 872   | 332 | 750 | 332 | 2000 |   |
| GX040620* | 1 2 | 100x100; r=55 <sup>7</sup>                             | 968 - 972   | 968 - 972   | 432 | 750 | 432 | 2000 |   |
| GX040720* | 1 2 | 120x120; r=55 <sup>7</sup>                             | 1168 - 1172 | 1168 - 1172 | 632 | 750 | 632 | 2000 |   |

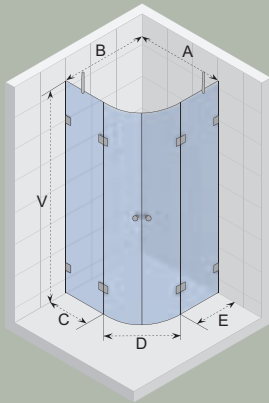

### M309

|           |  | Sprchová vanička (cm)<br>Shower tray<br>Душевой поддон |             | A           | B   | C   | D   | E    | V |
|-----------|--|--|-------------|-------------|-----|-----|-----|------|---|
| GX0440300 |  | 90x90; r=55 <sup>7</sup>                               | 868 - 872   | 868 - 872   | 332 | 750 | 332 | 2000 |   |
| GX0460300 |  | 100x100; r=55 <sup>7</sup>                             | 968 - 972   | 968 - 972   | 432 | 750 | 432 | 2000 |   |
| GX0470300 |  | 120x120; r=55 <sup>7</sup>                             | 1168 - 1172 | 1168 - 1172 | 632 | 750 | 632 | 2000 |   |

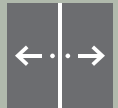

Formulář pro atypické provedení SCANDIC umístěn  
na [www.riho.com](http://www.riho.com)

Form for atypical SCANDIC showers green placed on  
[www.riho.com](http://www.riho.com)

Форма для нестандартного исполнения шторки SCANDIC  
[www.riho.com](http://www.riho.com)



oblé sklo/bended glass/круглое остекло



viz. str. 84/see page 84/см. стр. 84

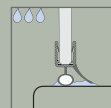
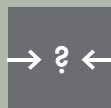
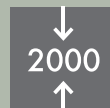

# FJORD



F203



F308

## F203

Sprohová vanička (cm)  
Shower tray  
Душевой поддон

|                                 | A         | B         | C   | D   | E   | F   | V    |
|---------------------------------|-----------|-----------|-----|-----|-----|-----|------|
| 90x90                           | 853-868   | 853-868   | 305 | 565 | 565 | 305 | 2000 |
| 100x100                         | 953-968   | 953-968   | 405 | 565 | 565 | 405 | 2000 |
| 120x120                         | 1153-1168 | 1153-1168 | 605 | 565 | 565 | 605 | 2000 |
| Příklad asymetrického provedení |           |           |     |     |     |     |      |
| 100x90                          | 953-968   | 853-868   | 405 | 565 | 565 | 305 | 2000 |
| 120x90                          | 1153-1168 | 853-868   | 605 | 565 | 565 | 305 | 2000 |
| 120x100                         | 1153-1168 | 953-968   | 605 | 565 | 565 | 405 | 2000 |

Vstup/Entry/Проход = 76 cm

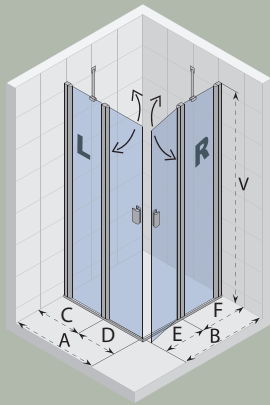

|              |  |                    |
|--------------|--|--------------------|
| GFB0304801   | Fjord čtverec/square/квадрат 860x2000  | levá/left/левая    |
| L GFB0305801 | Fjord čtverec/square/квадрат 960x2000  | levá/left/левая    |
| GFB0307801   | Fjord čtverec/square/квадрат 1160x2000 | levá/left/левая    |
| GFB0304802   | Fjord čtverec/square/квадрат 860x2000  | pravá/right/правая |
| R GFB0305802 | Fjord čtverec/square/квадрат 960x2000  | pravá/right/правая |
| GFB0307802   | Fjord čtverec/square/квадрат 1160x2000 | pravá/right/правая |

Lze kombinovat různé rozměry levé a pravé části.

5

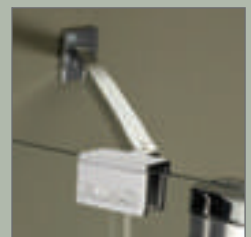
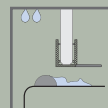
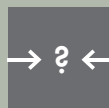
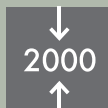

# FJORD

## F308

Sprchová vanička (cm)  
Shower tray  
Душевой поддон

|                                 | A         | B         | C   | D   | E   | F   | V    |
|---------------------------------|-----------|-----------|-----|-----|-----|-----|------|
| 90x90; r=55                     | 855-870   | 855-870   | 320 | 550 | 550 | 320 | 2000 |
| 100x100; r=55                   | 955-970   | 955-970   | 420 | 550 | 550 | 420 | 2000 |
| 120x120; r=55                   | 1155-1170 | 1155-1170 | 620 | 550 | 550 | 620 | 2000 |
| Příklad asymetrického provedení |           |           |     |     |     |     |      |
| 100x90; r=55                    | 955-970   | 855-870   | 420 | 550 | 550 | 320 | 2000 |
| 120x90; r=55                    | 1155-1170 | 855-870   | 620 | 550 | 550 | 320 | 2000 |
| 120x100; r=55                   | 1155-1170 | 955-970   | 620 | 550 | 550 | 420 | 2000 |

Vstup/Entry/Проход = 76 cm

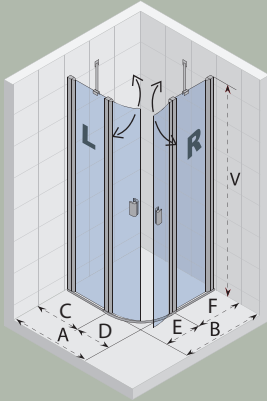

|              |                                   |           |                    |
|--------------|-----------------------------------|-----------|--------------------|
| GFB0204801   | Fjord čtvrtkruh/quadrant/квадрант | 860x2000  | levá/left/левая    |
| L GFB0205801 | Fjord čtvrtkruh/quadrant/квадрант | 960x2000  | levá/left/левая    |
| GFB0207801   | Fjord čtvrtkruh/quadrant/квадрант | 1160x2000 | levá/left/левая    |
| GFB0204802   | Fjord čtvrtkruh/quadrant/квадрант | 860x2000  | pravá/right/правая |
| R GFB0205802 | Fjord čtvrtkruh/quadrant/квадрант | 960x2000  | pravá/right/правая |
| GFB0207802   | Fjord čtvrtkruh/quadrant/квадрант | 1160x2000 | pravá/right/правая |

Lze kombinovat různé rozměry levé a pravé části.



Sprchové zástěny/Shower screens/Душевые шторы

5

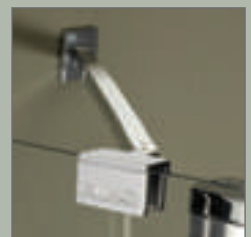
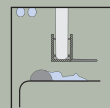
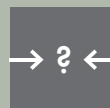
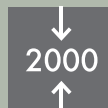

# FJORD / NAUTIC

# COMBI

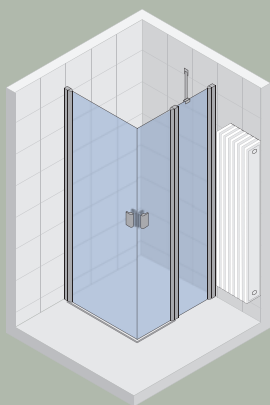

Nautic čtverec/square/квадрант  
Fjord čtverec/square/квадрант

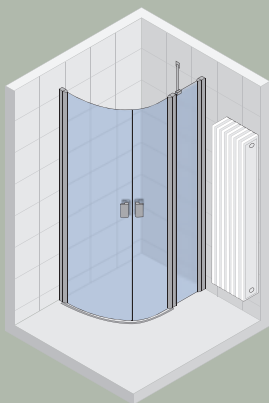

Nautic čtvrtkruh/quadrant/квадрант  
Fjord čtvrtkruh/quadrant/квадрант

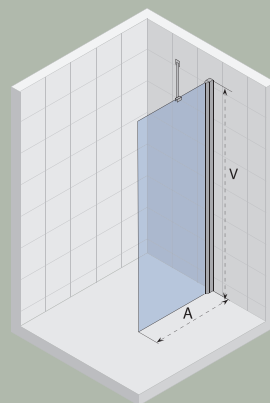

| combi      | Sprchová vanička (cm)<br>Shower tray<br>Душевой поддон |           | A    | V |
|------------|--|-----------|------|---|
|            | 90   | 100       |      |   |
| GGB0904800 | 90   | 855 - 869 | 2000 |   |
| GGB0905800 | 100  | 955 - 969 | 2000 |   |

## Doplňky/Option/Дополнительное оборудование

sedátko černé/seat - black/черное сидение

vybavení za příplatek / option /опция

rozměry / size / размер 36x35 cm

nosnost / maximum load / Максимальный вес 130 kg

Nesmí být použito pro porobetonové zdi/

it can not be used for aerococoncrete walls/

Не разрешается использовать для пенобетонových стен

## Fjord / Nautic Fixed Wall/

### Фиксируемая стена Fjord

Možnost kombinovat s Fjord

- dveře do niky/possible combination  
with fjord nika door/

Возможные положения двери Fjord



Sedátko bez opěrky/Seat without back/Сидение без спинки  
AS02110



Sedátko s opěrkou/Seat with back/Сидение со спинкой AS02115

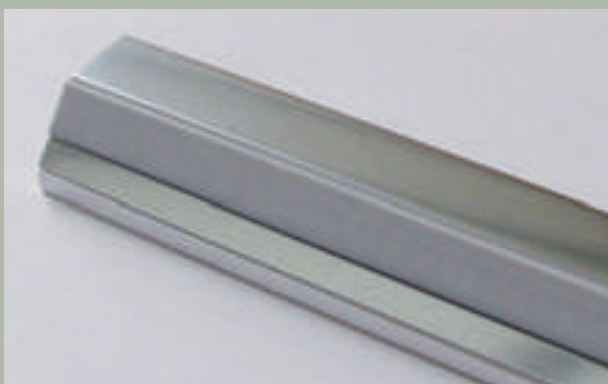

Bez rozšiřovacího profilu/without extender profile/  
Без расширительного профиля

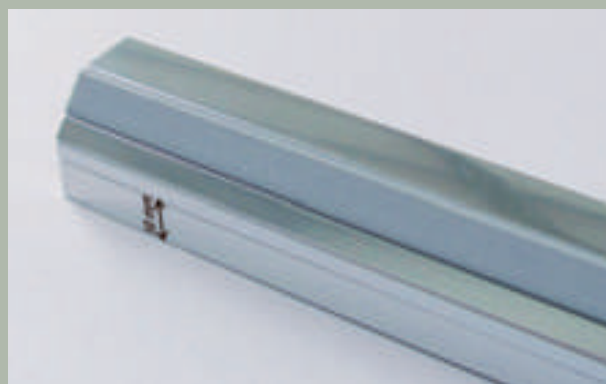

Rozšiřovací profil/Extender Profile/Регулирующий профиль  
160108925

10 mm extra pomocí nabízeného profilu/  
extra 10mm by offered profile/

Увеличивает ширину профиля на 10 мм

Lze použít pro N101, S101, M101, S104, M104, W104, S105  
Possible to used by N101, S101, M101, S104, M104, W104, S105  
можно использовать N101, S101, M101, S104, M104, W104, S105

# FJORD - pevná stěna/Walk In/Прходная шторка



ilustrační foto/illustration photo/иллюстративное фото

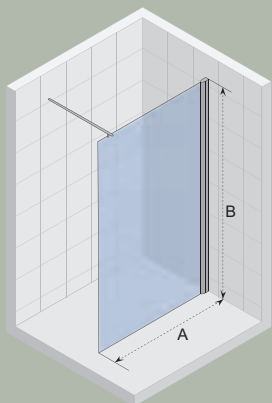

F400'

Sprchová vanička (cm)  
Shower tray  
Душевой поддон

|            |     | A         | V    |
|------------|-----|-----------|------|
| GFB0105800 | 100 | 963-977   | 2000 |
| GFB0107800 | 120 | 1163-1177 | 2000 |
| GFB0108800 | 140 | 1363-1377 | 2000 |
| GFB0109800 | 160 | 1563-1577 | 2000 |

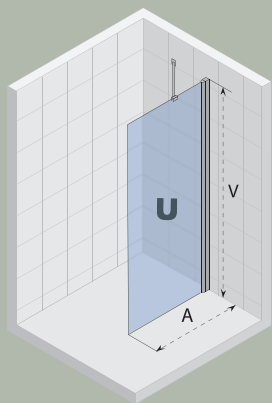

F401

Sprchová vanička (cm)  
Shower tray  
Душевой поддон

|            |     | A       | V    |
|------------|-----|---------|------|
| GFB0002800 | 80  | 763-777 | 2000 |
| GFB0004800 | 90  | 863-877 | 2000 |
| GFB0005800 | 100 | 963-977 | 2000 |

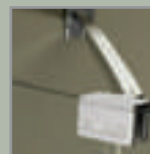

Sprchové zástěny/Shower screens/Душевые шторки

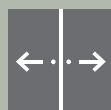
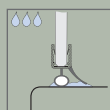
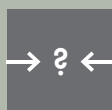
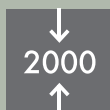



# NAUTIC



N101



N111

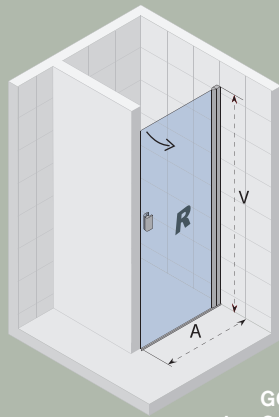
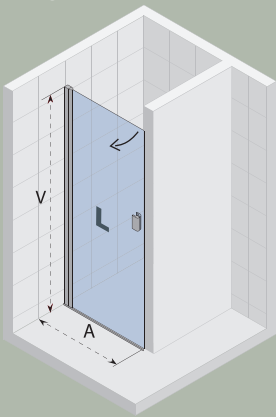

## N101

Sprchová vanička (cm)  
Shower tray  
Душевой поддон

|     | A       | V    |
|-----|---------|------|
| 70  | 676-696 | 2000 |
| 80  | 776-796 | 2000 |
| 90  | 876-896 | 2000 |
| 100 | 976-996 | 2000 |

- GGB0600801 Nautic dveře do niky/nika door 680x2000 levá/left/левая
- L GGB0602801 Nautic dveře do niky/nika door 780x2000 levá/left/левая
- GGB0604801 Nautic dveře do niky/nika door 880x2000 levá/left/левая
- GGB0605801 Nautic dveře do niky/nika door 980x2000 levá/left/левая
- GGB0600802 Nautic dveře do niky/nika door 680x2000 pravá/right/правая
- R GGB0602802 Nautic dveře do niky/nika door 780x2000 pravá/right/правая
- GGB0604802 Nautic dveře do niky/nika door 880x2000 pravá/right/правая
- GGB0605802 Nautic dveře do niky/nika door 980x2000 pravá/right/правая

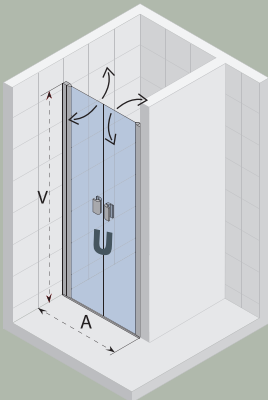

## N111

Sprchová vanička (cm)  
Shower tray  
Душевой поддон

|     | A       | V    |
|-----|---------|------|
| 80  | 772-792 | 2000 |
| 90  | 872-892 | 2000 |
| 100 | 972-992 | 2000 |

- GGB0802800 Nautic Swing 780x2000 Univers.
- GGB0804800 Nautic Swing 880x2000 Univers.
- GGB0805800 Nautic Swing 980x2000 Univers.

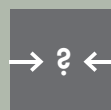
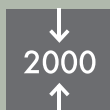

# NAUTIC



N209



N308

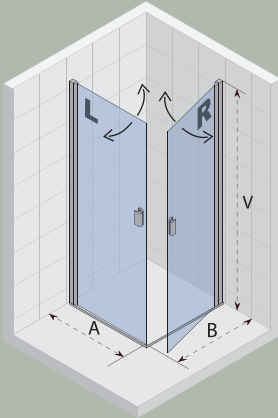

N209

| Sprchová vanička (cm)<br>Shower tray<br>Душевой поддон |         |         |      |  |
|--|---------|---------|------|--|
|  | A       | B       | V    |  |
| 80x80  | 757-767 | 757-767 | 2000 |  |
| 90x90  | 857-867 | 857-867 | 2000 |  |
| 100x100  | 957-967 | 957-967 | 2000 |  |
| Příklad asymetrického provedení                        |         |         |      |  |
| 90x80  | 857-867 | 757-767 | 2000 |  |
| 100x80   | 957-967 | 757-767 | 2000 |  |
| 100x90   | 957-967 | 857-867 | 2000 |  |

|              |                               |          |                    |
|--------------|-------------------------------|----------|--------------------|
| GGB0302801   | Nautic čtverec square/квадрат | 760x2000 | levá left/левая    |
| L GGB0304801 | Nautic čtverec square/квадрат | 860x2000 | levá left/левая    |
| GGB0305801   | Nautic čtverec square/квадрат | 960x2000 | levá left/левая    |
| GGB0302802   | Nautic čtverec square/квадрат | 760x2000 | pravá right/правая |
| R GGB0304802 | Nautic čtverec square/квадрат | 860x2000 | pravá right/правая |
| GGB0305802   | Nautic čtverec square/квадрат | 960x2000 | pravá right/правая |

Lze kombinovat různé rozměry levé a pravé části.  
It is possible to combine various dimensione of L/R part  
Можно комбинировать различные размеры левых и правых частей

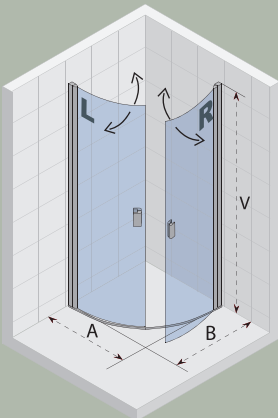

N308

| Sprchová vanička (cm)<br>Shower tray<br>Душевой поддон |         |         |      |  |
|--|---------|---------|------|--|
|  | A       | B       | V    |  |
| 90x90; r=55  | 858-868 | 858-868 | 2000 |  |

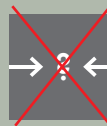

|              |                                    |          |                    |
|--------------|------------------------------------|----------|--------------------|
| L GGB0204801 | Nautic čtvrtkruh quadrant/квадрант | 860x2000 | levá left/левая    |
| R GGB0204802 | Nautic čtvrtkruh quadrant/квадрант | 860x2000 | pravá right/правая |

5

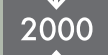

# LUCENA

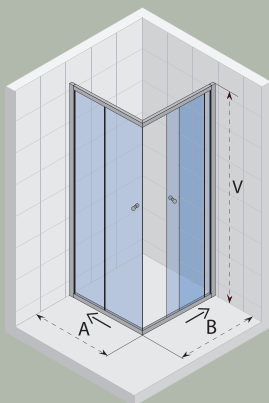

## Čtverec/Square/Квадрат

|         | Sprchová vanička (cm)<br>Shower tray<br>Душевой поддон | A          | B          | V    | vstup<br>entry<br>вход |
|---------|--|------------|------------|------|------------------------|
| GK32200 | 80x80  | 783 - 803  | 783 - 803  | 1950 | 420                    |
| GK34200 | 90x90  | 883 - 903  | 883 - 903  | 1950 | 420                    |
| GK36200 | 100x100  | 983 - 1003 | 983 - 1003 | 1950 | 520                    |

## Díl s dveřmi Door part Дверная часть

|                       | A           | V    |
|-----------------------|-------------|------|
| GKB32200 <sup>2</sup> | 783 - 803   | 1950 |
| GKB34200 <sup>2</sup> | 883 - 903   | 1950 |
| GKB36200 <sup>2</sup> | 983 - 1003  | 1950 |
| GKB38200 <sup>2</sup> | 1183 - 1203 | 1950 |

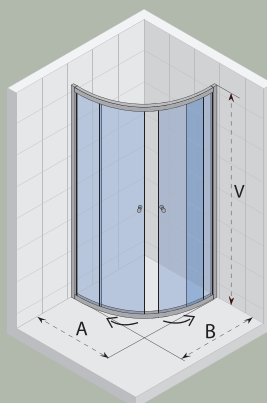

## Čtvrtek R 55 cm/Quadrant/Квадрат

|         | Sprchová vanička (cm)<br>Shower tray<br>Душевой поддон | A          | B          | V    | vstup<br>entry<br>вход |
|---------|--|------------|------------|------|------------------------|
| GK22200 | 80x80; r=55  | 783 - 803  | 783 - 803  | 1950 | 400                    |
| GK24200 | 90x90; r=55  | 883 - 903  | 883 - 903  | 1950 | 540                    |
| GK26200 | 100x100; r=55  | 983 - 1003 | 983 - 1003 | 1950 | 540                    |
| GK12200 | 90x90; r=55  | 883 - 903  | 883 - 903  | 1500 | 540                    |

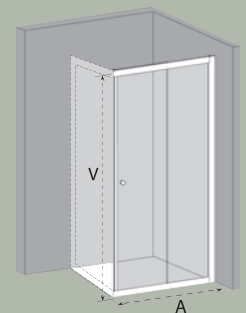

Sprchové zástěny/Shower screens/Душевые шторы

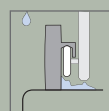
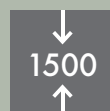
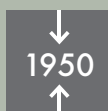

# HAMAR

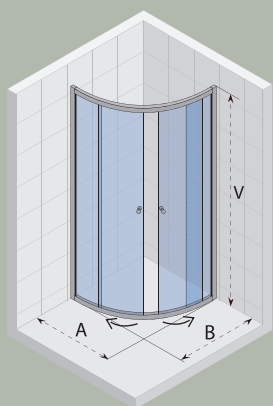

| Sprchový kout<br>Shower enclosure<br>Душевой уголок | Rozměr (cm)<br>Dimensions (cm)<br>Размер (cm) | A          | B          | V    | vstup<br>entry<br>вход |
|---|---|------------|------------|------|------------------------|
| GR32200   | quadrant/квадрант 80x80; r=55                 | 770 - 805  | 770 - 805  | 1950 | 480                    |
| GR33200   | quadrant/квадрант 90x90; r=55                 | 870 - 905  | 870 - 905  | 1950 | 500                    |
| GR35200   | quadrant/квадрант 100x100; r=55               | 970 - 1005 | 970 - 1005 | 1950 | 500                    |

Výška 195cm, čiré bezpečnostní sklo 6mm, posuvné dveře, profil Al –pochromovaný  
 Height 195cm, glass-safety-thickness 6mm, sliding doors, profile colour chrome  
 Высота 195см, прозрачное безопасное стекло 6 мм, раздвижные двери, профиль хромированный

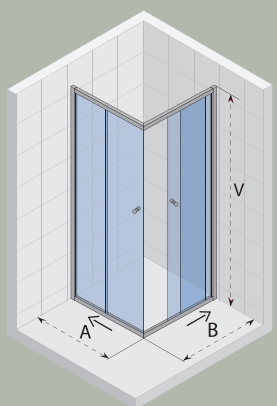

| Sprchový kout<br>Shower enclosure<br>Душевой угол | Rozměr (cm)<br>Dimensions (cm)<br>Размер (cm) | A          | B          | V    | vstup<br>entry<br>вход |
|---|---|------------|------------|------|------------------------|
| GR53200   | čtverec/square/квadrat 80x80                  | 770 - 805  | 770 - 805  | 1950 | 410                    |
| GR54200   | čtverec/square/квadrat 90x90                  | 870 - 905  | 870 - 905  | 1950 | 480                    |
| GR56200   | čtverec/square/квadrat 100x100                | 970 - 1005 | 970 - 1005 | 1950 | 480                    |



2

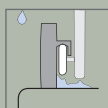
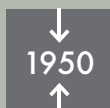

# LUCENA

komplet/set/комплект

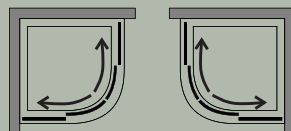

kód/code/код GSET021 90x90x202 cm; R 55  
 vanička s podpěrami a panelem/  
 shower tray incl. props and front panel/  
 поддон с опорами и панелью DB 43  
 zástěna/shower screen/шторка LUCENA  
 (výška/height/высота 150 cm)

profil Al - pochromovaný.  
 profile color chrome.  
 профиль Al - хромированный.

Bezpečnostní sklo 6 mm – sklo, posuvné dveře, profil Al - pochromovaný  
 Glass safety, thickness 6 mm – glass, sliding doors, profile colour chrome  
 Безопасное стекло 6 мм – стекло, раздвижные двери, белый профиль Al - хромированный



ilustrační foto/illustration photo/иллюстративное фото

# POTISK SKLA SPRCHOVÝCH ZÁSTĚŇ, SATINATO

(SCANDIC, POLAR, BALTIC) Nutno udat L/P provedení

# SHOWER SCREENS WITH PRINTED GLASS, SATINATO

(SCANDIC, POLAR, BALTIC) Necessary to specify L/P

# ДУШЕВЫЕ ШТОРКИ С ПЕЧАТНЫМ ДЕКОРОМ, SATINATO

(SCANDIC, POLAR, BALTIC) НЕОБХОДИМО УТОЧНИТЬ: ЛЕВОЕ ИЛИ ПРАВОЕ ИСПОЛНЕНИЕ L/P



## Možnosti potisku skel/Printed Glass/Образцы декора на стекле

**DEKOR 1**  
**ДЕКОР 1**

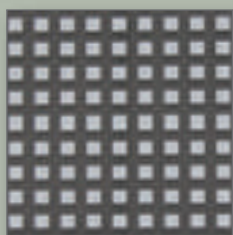

**DEKOR 2**  
**ДЕКОР 2**

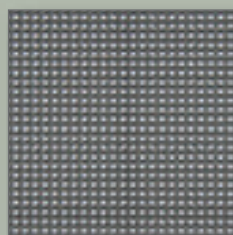

**DEKOR 3**  
**ДЕКОР 3**

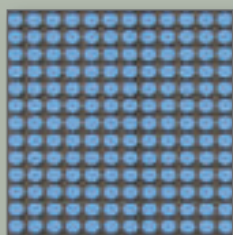

**DEKOR 4**  
**ДЕКОР 4**

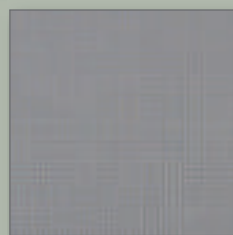

**DEKOR 5**  
**ДЕКОР 5**

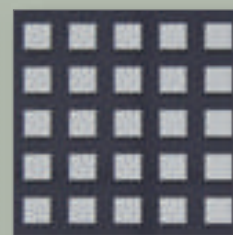

Potisk skla u sprchových zástěň Scandic a Polar. Potisk, ani provedení satinato nelze provést u zástěň P204, S308, W308, M308, S309, W309, M309.

Printed glass is offered at shower screens Scandic and Polar – Printing and Satinato except P204, S308, W308, M308, S309, W309, M309.

Предлагаем для душевых шторок серии Скандик (Scandic) и Полар (Polar), Печатный декор ни молочное стекло ( SATINATO ) нельзя у шторок P204, S308, W308, M308, S309, W309, M309.

### **DEKOR 1** **ДЕКОР 1**

velikost vzoru: 8x8 mm  
mezera: 7 mm  
hustota tisku: 30%  
printing density: 30%

размер рисунка 8 x 8 мм  
промежуток 7 мм  
плотность печати 30%

### **DEKOR 2** **ДЕКОР 2**

vzor: Ø 3 mm  
mezera: 2,5 mm  
hustota tisku: 28%  
printing density: 28%

рисунок Ø 3 мм  
промежуток 2,5 мм  
плотность печати 28%

### **DEKOR 3** **ДЕКОР 3**

vzor: Ø 8 mm  
mezera: 2 mm  
hustota tisku: 30%  
printing density: 30%

рисунок Ø 8 мм  
промежуток 2 мм  
плотность печати 30%

### **DEKOR 4** **ДЕКОР 4**

vzor: Ø 1,5 mm  
mezera: 1,5 mm  
hustota tisku: 78%  
printing density: 78%







рисунок Ø 1,5 мм  
промежуток 1,5 мм  
плотность печати 78%

### **DEKOR 5** **ДЕКОР 5**

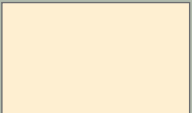
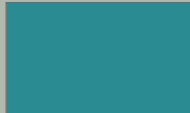
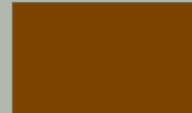
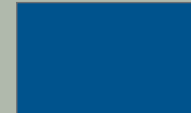
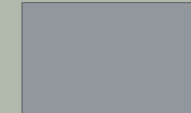
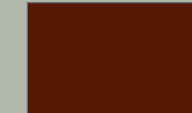
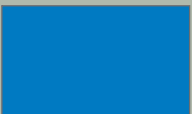
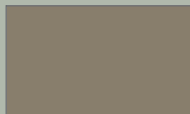
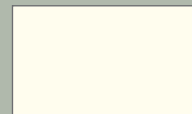
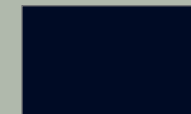
velikost vzoru: 15x15 mm  
mezera: 10 mm  
hustota tisku: 25%  
printing density: 25%

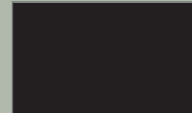
размер рисунка 15 x 15 мм  
промежуток 10 мм  
плотность печати 25%

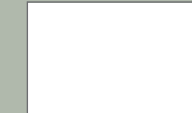
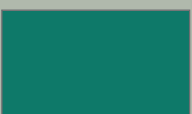
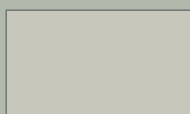
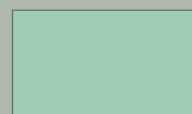
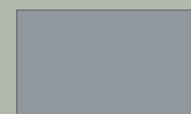
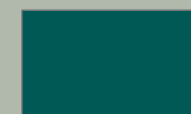
# Vzorník barev RAL/Colour card RAL/Цветовая палитра RAL

|  |  |   |  |  |   |
|--|--|---|--|--|---|
| <p>ústřicově bílá<br/>Oyster white<br/>Перламутрово-белый</p>  <p><b>1013</b></p> | <p>mint<br/>Mint<br/>Мята</p>  <p><b>6033</b></p>                               | <p>signální hnědá<br/>Signal brown<br/>Сигнальный коричневый</p>  <p><b>8002</b></p> | <p>jasně modrá<br/>Brilliant blue<br/>Ярко-синий</p>  <p><b>5007</b></p>          | <p>stříbrno-šedá<br/>Silver grey<br/>Серебристо-серый</p>  <p><b>7001</b></p> | <p>čokoládově hnědá<br/>Chocolate brown<br/>Шоколадно-коричневый</p>  <p><b>8017</b></p> |
| <p>světle modrá<br/>Light blue<br/>Голубой</p>  <p><b>5012</b></p>                | <p>popelavě hnědá<br/>Moss grey<br/>Пепельно-коричневый</p>  <p><b>7033</b></p> | <p>signální bílá<br/>Signal white<br/>Сигнальный белый</p>  <p><b>9003</b></p>       | <p>kobaltová modř<br/>Cobalt blue<br/>Синий кобальт</p>  <p><b>5013</b></p>       | <p>antracitová<br/>Anthracite grey<br/>Серый антрацит</p>  <p><b>7016</b></p> | <p>signální černá<br/>Signal black<br/>Сигнальный черный</p>  <p><b>9004</b></p>         |
| <p>námořní modrá<br/>Ocean blue<br/>Цвет морской волны</p>  <p><b>5020</b></p>    | <p>šedá – granit<br/>Granite grey<br/>Серый гранит</p>  <p><b>7024</b></p>      | <p>černá<br/>Black<br/>Черный</p>  <p><b>141001-černá</b></p>                        | <p>pastelově modrá<br/>Pastel blue<br/>Пастельный голубой</p>  <p><b>5024</b></p> | <p>modro-šedá<br/>Blue grey<br/>Сине-серый</p>  <p><b>7031</b></p>            | <p>bílá<br/>White<br/>Белый</p>  <p><b>194011-bílá</b></p>                               |
| <p>zastřená zelená<br/>Patina green<br/>Зеленая патина</p>  <p><b>6000</b></p>   | <p>světle šedá<br/>Light grey<br/>Светло-серый</p>  <p><b>7035</b></p>         | <p>pastelově zelená<br/>Pastel green<br/>Пастельный zelený</p>  <p><b>6019</b></p>  | <p>šedá<br/>Window grey<br/>Серый</p>  <p><b>7040</b></p>                        | <p>opálově zelená<br/>Opal green<br/>Зеленý опал</p>  <p><b>6026</b></p>     | <p>tmavě šedá<br/>Traffic grey<br/>Темно-серый</p>  <p><b>7043</b></p>                  |

Zobrazené odstíny barev RAL nemusí přesně odpovídat originálu z důvodu odlišného vnímání vytištěného vzorníku barev.  
Painted colour shade RAL need not exactly correspond with original, because of the different colour perception of the printed colour card.  
Изображенные оттенки цветов RAL не должны точно соответствовать оригиналу в силу различия в восприятии печатной палитры цветов



# Vysvětlivky/Information/Обозначения

2

2 roky záruka  
2 years guarantee  
Гарантия 2 года

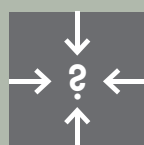

Možné atypické provedení (šířka, výška)  
Customised version possible (Width, Height)  
Возможность нестандартного исполнения (ширина, высота)

5

5 let záruka na sklo  
5 years guarantee on glass  
Гарантия 5 лет на стекло

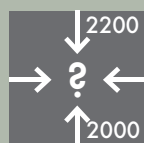

Možné atypické provedení (šířka, výška)  
Výška zástěny 2000/ 2200 mm  
Customised version possible (Width, Height)  
Height of the shower screen 2000/ 2200 mm  
Возможность нестандартного исполнения (ширина, высота) Высота шторки 2000 мм/2200 мм



Povrchová úprava RIHO Shield  
RIHO Shield surface finish  
Поверхностная обработка RIHO Shield



Samozvedací pant  
Lifting hinge  
Самоподнимающая петля

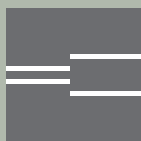

Rozšiřující profil  
Extended profile  
Расширительный профиль

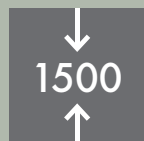

Výška zástěny 1500 mm  
Height of the shower screen 1500 mm  
Высота шторки 1500 мм



Samozvedací profil  
Lifting profile  
Самоподнимающийся профиль

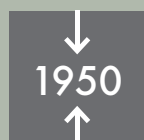

Výška zástěny 1950 mm  
Height of the shower screen 1950 mm  
Высота шторки 1950 мм

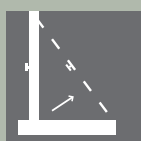

Snadné čištění pomocí vysazení pojezdu skla  
Easy cleaning thanks to system move out  
Простота очистки путём демонтажа профиля для движения стекла

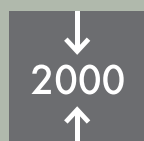

Výška zástěny 2000 mm  
Height of the shower screen 2000 mm  
Высота шторки 2000 мм



Kalené sklo dle normy EN 12150-1  
Safety glass according to standard EN 12150-1  
Закаленное стекло в соответствии с нормой EN 12150-1

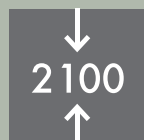

Výška zástěny 2100 mm  
Height of the shower screen 2100 mm  
Высота шторки 2100 мм



Tloušťka skla 6 mm  
Thickness of the safety glass 6 mm  
Толщина стекла 6 мм

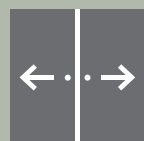

Univerzální zástěna pro levé i pravé provedení  
Universal shower screen for right and left execution  
Универсальный правый и левый вариант входа

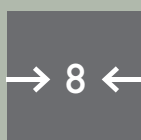

Tloušťka skla 8 mm  
Thickness of the safety glass 8 mm  
Толщина стекла 8 мм

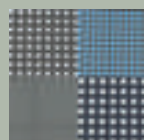

Možnost potisku skla  
Printed glass  
Возможность печати стекла

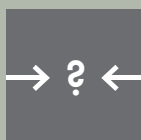

Možné atypické provedení (šířka)  
Customised version possible (Width)  
Возможность нестандартного исполнения (ширина)

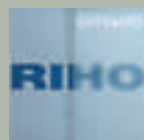

Mléčné sklo Satinato (za příplatek)  
Frosted glass Satinato (for extra charge)  
Молочное стекло Satinato (надбавка)

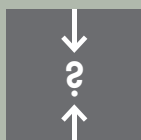

Možné atypické provedení (výška)  
Customised version possible (Height)  
Возможность нестандартного исполнения (высота)

# Informace/Information/Обозначения

## Těsnost sprchových zástěn

Všechny sprchové zástěny firmy RIHO jsou testovány dle obvyklých standardů na těsnost proti unikající vodě. Celé řešení sprchových zástěn je provedeno takovým způsobem, aby se minimalizovalo množství úniku vody. Zástěny jsou při běžném užívání odolné proti stříkající vodě. Drobný průnik vody je možný a není závadou výrobku. Stupeň těsnosti zástěn je dán označením.

## Tightness of shower screens

All RIHO's shower screens are tested according to usual standards for water tightness. The entire shower screen is designed in such a way as to minimize the amount of water leakage. In normal use, the screens are splash-proof. Mild water penetration is possible and is not a product defect. The screen tightness level is indicated.

## Герметичность душевых перегородок

Все душевые перегородки производства фирмы RIHO тестируются в соответствии с принятыми стандартами на герметичность протечки воды. Общее решение душевых перегородок осуществлено таким образом, чтобы свести к минимуму протечки воды. При обычном пользовании перегородки препятствуют разбрызгиванию воды. Мелкие протечки возможны, но не считаются дефектом данного изделия. Степень герметичности соответствует принятому обозначению.

## Stupně těsnosti zástěn

## Screen tightness levels

## Степень герметичности душевых перегородок

### Stupeň I.

Sprchové zástěny s obvodovým rámem poskytují nejvyšší stupeň těsnosti proti stříkající a stékající vodě.

### Level I.

Shower screens having a peripheral frame provide the highest degree of tightness against splashing or running water.

### Степень I.

Душевые перегородки с контурным профилем обеспечивают максимальную герметичность от разбрызгивания и стекания воды.

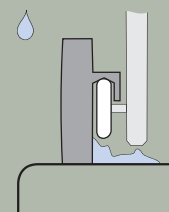

### Stupeň II.

Sprchové zástěny s plochým těsněním a prahovou lištou poskytují dobrou těsnost proti stříkající a stékající vodě, kde prahová lišta vytváří bariéru proti úniku vody ze sprchového koutu.

### Level II.

Shower screens with flat gasket and sill moulding provide a good seal against splashing or running water. The sill moulding forms a barrier against leakage of water out of the shower.

### Степень II.

Душевые перегородки с плоским уплотнением и профилем порожка обеспечивают хорошую герметичность от разбрызгивания и стекания воды, профиль порожка при этом служит в качестве барьера для предотвращения протечки воды из душевой кабины.

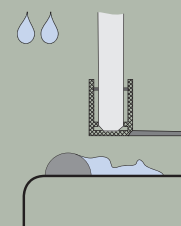

### Stupeň III.

Sprchové zástěny s těsněním pomocí dvou těsnících ploch poskytují dostatečnou ochranu proti stékající vodě. U těchto zástěn je vše podmíněno absolutní čistotě designu.

### Level III

The shower screens sealed by two sealing surfaces provide sufficient protection against running water. In case of these screens everything is subject to the absolute purity of design.

### Степень III.

Душевые перегородки с уплотнением, создаваемым двумя уплотнительными поверхностями, что обеспечивает достаточную защиту от стекания воды. У таких перегородок всё подчинено абсолютной чистоте дизайна.

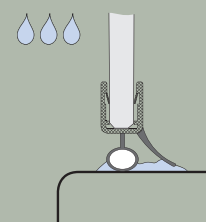

## Příslušenství/Accessories/Аксессуары



AT10125 Pojezdová tyč čtvercová mosaz chromovaná  
AT10125 Sliding bar square shape brass/chrome plated  
AT10125 Подвижная квадратная штанга латунь хромированная

AT20125 Hlavová sprcha nerez ocel chromovaná 30x30 cm G1/2  
AT20125 Headshower stainless steel chrome plated 30x30 cm G1/2  
AT20125 Головной душ - нержавеющая сталь хромированная 30 x 30 cm G1/2



AT22125 Hlavová sprcha nerez ocel chromovaná 30x30 cm G1/2  
AT22125 Headshower stainless steel chrome plated 30x30 cm G1/2  
AT22125 Головной душ - нержавеющая сталь хромированная 40 x 40 cm G1/2

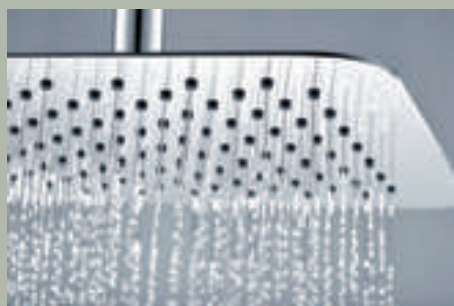

## Příslušenství/Accessories/Аксессуары



AT30125 Držák stropní hlavové sprchy kulatý mosaz chromovaná 200 mm  
AT30125 Headshower plafond wall bar brass round chrome plated 200 mm  
AT30125 Держатель потолочный головного душа – круглый, латунь хромированная 200 мм

AT32125 Držák horizontální hlavové sprchy kulatý mosaz chromovaná 400 mm  
AT32125 Headshower wall bar brass round chrome plated 400 mm  
AT32125 Держатель горизонтальный головного душа – круглый, латунь хромированная 400 мм



AT34125 Držák horizontální hlavové sprchy kulatý mosaz chromovaná 500 mm  
AT34125 Headshower wall bar brass round chrome plated 500 mm  
AT34125 Держатель горизонтальный головного душа – круглый, латунь хромированная 500 мм



AT40125 Držák stropní hlavové sprchy čtvercový mosaz chromovaná 200 mm  
AT40125 Headshower plafond bar brass square chrome plated 200 mm  
AT40125 Держатель потолочный головного душа – квадратный, латунь хромированная 200 мм

AT42125 Držák horizontální hlavové sprchy čtvercový mosaz chromovaná 400 mm  
AT42125 Headshower wall bar brass square chrome plated 400 mm  
AT42125 Держатель горизонтальный головного душа – квадратный, латунь хромированная 400 мм

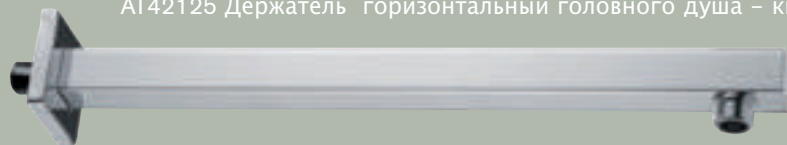

AT44125 Držák horizontální hlavové sprchy čtvercový mosaz chromovaná 500 mm  
AT44125 Headshower wall bar brass square chrome plated 500 mm  
AT44125 Держатель горизонтальный головного душа – квадратный, латунь хромированная 500 мм

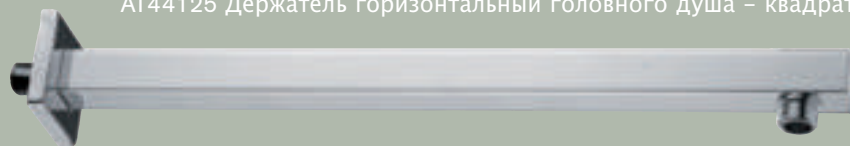

AT50125 Ruční sprcha nastavitelná chrom/bílá plast  
AT50125 Headshower adjustable chrome/white plastic  
AT50125 Ручной душ настраиваемый - комбинация хром/белый пласт

LITÝ MRAMOR/SYNTETIC MARBLE/ЛИТОЙ МРАМОР

Sprchové vaničky KOLPING jsou dodávány včetně podpěr a výpustí.  
KOLPING shower trays are supplied with legs and discharge.  
Душевые поддоны KOLPING поставляются только в комплекте с подставками и водоспуском.

Výška sifonu 80 mm. / Siphon height 80 mm. / Высота сифона 80 мм.

**DB10** 80 x 80 cm



**DB14** 90 x 90 cm



**DB18** 100 x 100 cm



**P10** panel/cover



**P14** panel/cover



**P18** panel/cover



**DB20** 80 x 80 cm



**DB21** 90 x 90 cm



**P20** panel/cover

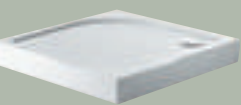

**P21** panel/cover

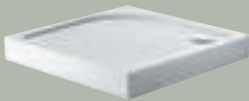

**DB 31** 100 x 80 cm

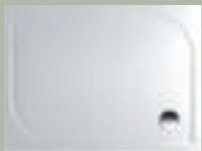

**DB32** 100 x 90 cm



**DB34** 120 x 90 cm



**DB36** 140 x 90 cm



**P31** panel R/cover R

**P32** panel L/cover L



**P35** panel R/cover R

**P36** panel L/cover L

**P37** panel R/cover R

**P38** panel L/cover L

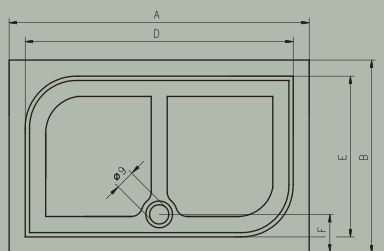

**DB33** 120 x 80 cm



**P33** panel R/cover R

**P34** panel L/cover L

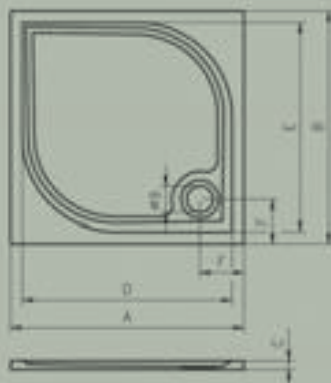

| model | A (cm) | B (cm) | C (cm) | D (cm) | E (cm) | F (cm) |
|-------|--------|--------|--------|--------|--------|--------|
| DB 10 | 80     | 80     | 3      | 72     | 72     | 15     |
| DB 14 | 90     | 90     | 3      | 82     | 82     | 18,5   |
| DB 18 | 100    | 100    | 3      | 92     | 92     | 18,5   |
| DB 20 | 80     | 80     | 3      | 72     | 72     | 15     |
| DB 21 | 90     | 90     | 3      | 82     | 82     | 18,5   |
| DB 31 | 100    | 80     | 3      | 92     | 72     | 15,5   |
| DB 32 | 100    | 90     | 3      | 92     | 82     | 18,5   |
| DB 33 | 120    | 80     | 3      | 112    | 72     | 15     |
| DB 34 | 120    | 90     | 3      | 105    | 75     | 19     |
| DB 36 | 140    | 90     | 3      | 125    | 75     | 18     |

výška panelu 9,5 cm / height of panel 9.5 cm

AKRYL/ACRYL/АКРИЛ

**248** 80 x 80 x 4,5

**249\*** 80 x 80 x 14

**250** 90 x 90 x 4,5

**251\*** 90 x 90 x 14

**260** 100 x 100 x 4,5

**261\*** 100 x 100 x 14

**252** 100 x 90 x 4,5

**253\*** 100 x 90 x 14

**254** 120 x 90 x 4,5

**255\*** 120 x 90 x 14

**256** 140 x 90 x 4,5

**257\*** 140 x 90 x 14

**258** 160 x 90 x 4,5

**259\*** 160 x 90 x 14

**276** 180 x 90 x 5

**270** 90 x 80 x 4,5

**271\*** 90 x 80 x 14

**272** 100 x 80 x 4,5

**273\*** 100 x 80 x 14

**274** 120 x 80 x 4,5

**275\*** 120 x 80 x 14

**278** 80 x 80 x 4,5 R55

**279\*** 80 x 80 x 14 R55

**280** 90 x 90 x 4,5 R55

**281\*** 90 x 90 x 14 R55

**284** 100 x 100 x 4,5 R55

**285\*** 100 x 100 x 14 R55

**288** 120 x 120 x 4,5 R55

**289\*** 120 x 120 x 14 R55

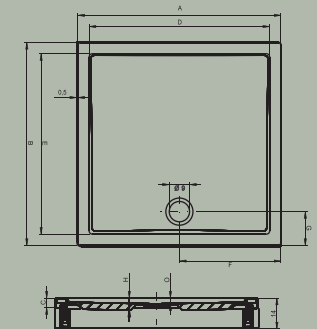
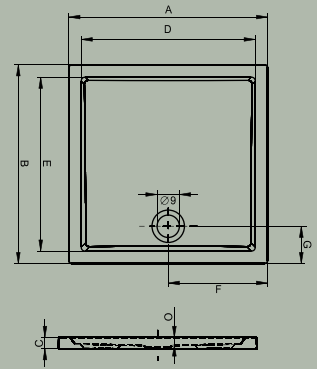
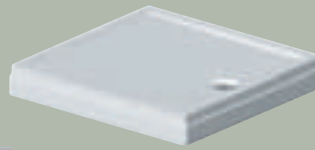
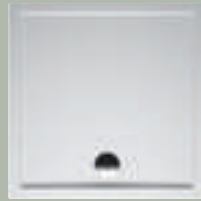

| model | code | model | code | A (cm) | B (cm) | C (cm) | D (cm) | E (cm) | F (cm) | G (cm) | O (cm) |
|-------|------|-------|------|--------|--------|--------|--------|--------|--------|--------|--------|
| 248   | DA56 | 249*  | DA57 | 80     | 80     | 4,5    | 70     | 70     | 40     | 15     | 2,5    |
| 250   | DA58 | 251*  | DA59 | 90     | 90     | 4,5    | 80     | 80     | 45     | 15     | 2,5    |
| 252   | DA60 | 253*  | DA61 | 100    | 90     | 4,5    | 90     | 80     | 50     | 15     | 2,5    |
| 254   | DA62 | 255*  | DA63 | 120    | 90     | 4,5    | 110    | 80     | 60     | 15     | 2,5    |
| 256   | DA64 | 257*  | DA65 | 140    | 90     | 4,5    | 130    | 80     | 70     | 15     | 2,5    |
| 258   | DA66 | 259*  | DA67 | 160    | 90     | 4,5    | 150    | 80     | 80     | 15     | 2,5    |
| 260   | DA68 | 261*  | DA69 | 100    | 100    | 4,5    | 90     | 90     | 50     | 15     | 2,5    |
| 270   | DA70 | 271*  | DA71 | 90     | 80     | 4,5    | 80     | 70     | 45     | 15     | 2,5    |
| 272   | DA72 | 273*  | DA73 | 100    | 80     | 4,5    | 90     | 70     | 50     | 15     | 2,5    |
| 274   | DA74 | 275*  | DA75 | 120    | 80     | 4,5    | 110    | 70     | 60     | 15     | 2,5    |
| 276   | DA84 |       |      | 180    | 90     | 5      | 170    | 80     | 90     | 15     | 2,5    |

\* s nohami a panelem  
Celková výška 14 cm

\*incl. legsand cover panel  
Total height 14 cm

\* с ножками и панелью  
Высота 14 см

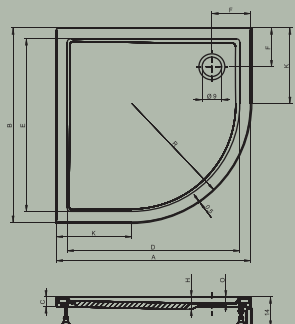
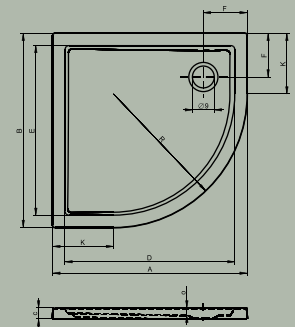

| model | code | model | code | A (cm) | B (cm) | C (cm) | D (cm) | E (cm) | F (cm) | K (cm) | O (cm) | R (cm) |
|-------|------|-------|------|--------|--------|--------|--------|--------|--------|--------|--------|--------|
| 278   | DA86 | 279*  | DA87 | 80     | 80     | 4,5    | 70     | 70     | 18     | 25     | 3      | 55     |
| 280   | DA88 | 281*  | DA89 | 90     | 90     | 4,5    | 80     | 80     | 18     | 35     | 3      | 55     |
| 284   | DA92 | 285*  | DA93 | 100    | 100    | 4,5    | 90     | 90     | 18     | 45     | 3      | 55     |
| 288   | DA96 | 289*  | DA97 | 120    | 120    | 4,5    | 110    | 110    | 22     | 65     | 3      | 55     |

\* s nohami a panelem  
Celková výška 14 cm

\*incl. legsand cover panel  
Total height 14 cm

\* с ножками и панелью  
Высота 14 см

AKRYL/ACRYL/АКРИЛ



**207** 90 x 90 x 8,5

**210\*** 90 x 90 x 8,5

| model | code | A (cm) | B (cm) | C (cm) | D (cm) | E (cm) | F (cm) | H (cm) | K (cm) | O (cm) | R (cm) |
|-------|------|--------|--------|--------|--------|--------|--------|--------|--------|--------|--------|
| 207   | DA21 | 90     | 90     | 3,5    | 74     | 74     | 18,5   | 11     | 35     | 8,5    | 55     |
| 210*  | DA19 | 90     | 90     | 3,5    | 74     | 74     | 18,5   | 11     | 35     | 8,5    | 55     |

\* s nohami a panelem / incl. legs and cover panel/с ножками и панелью

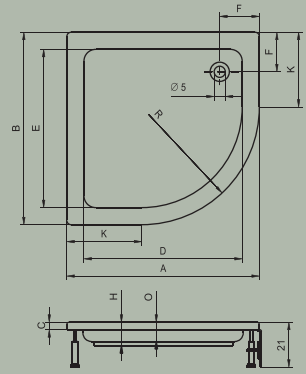

**213** 90 x 90 x 5

**215** 100 x 100 x 5

| model | code | A (cm) | B (cm) | C (cm) | D (cm) | E (cm) | F (cm) | H (cm) | K (cm) | M (cm) | O (cm) |
|-------|------|--------|--------|--------|--------|--------|--------|--------|--------|--------|--------|
| 213   | DA23 | 90     | 90     | 3,5    | 79,5   | 79,5   | 20     | 7,5    | 39,5   | 70,5   | 5      |
| 215   | DA26 | 100    | 100    | 3,5    | 89,5   | 89,5   | 19,5   | 7,5    | 50     | 70     | 5      |

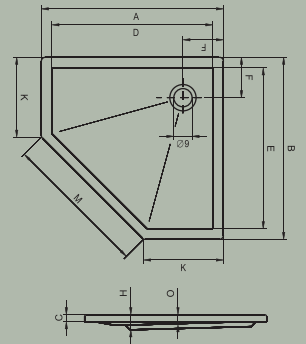

**APOLLO** 80 x 80 x 13

**SATURNUS** 90 x 90 x 15,5

| model    | code | A (cm) | B (cm) | C (cm) | D (cm) | E (cm) | F (cm) | H (cm) | O (cm) |
|----------|------|--------|--------|--------|--------|--------|--------|--------|--------|
| APOLLO   | DC01 | 80     | 80     | 3,5    | 68     | 68     | 14     | 15     | 13     |
| SATURNUS | DC04 | 90     | 90     | 3,5    | 77     | 77     | 15,5   | 18     | 15,5   |

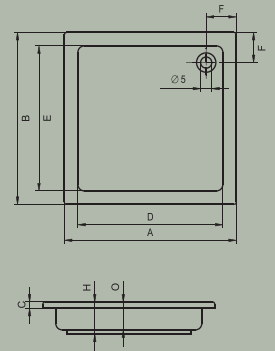

**342** 90 x 90 x 35

**343\*** 90 x 90 x 35

| model | code | A (cm) | B (cm) | C (cm) | D (cm) | E (cm) | F (cm) | H (cm) | K (cm) | M (cm) | O (cm) | R (cm) |
|-------|------|--------|--------|--------|--------|--------|--------|--------|--------|--------|--------|--------|
| 342   | DB42 | 90     | 90     | 3,5    | 77     | 77     | 59     | 38     | 35     | 32     | 35     | 55     |
| 343*  | DB43 | 90     | 90     | 3,5    | 77     | 77     | 59     | 38     | 35     | 32     | 35     | 55     |

\* s nohami a panelem / incl. legs and cover panel/с ножками и панелью

Za příplatek mechanická výpust s přepadem/Mechanical overflow filling for extra charge/доплата – водоспуск

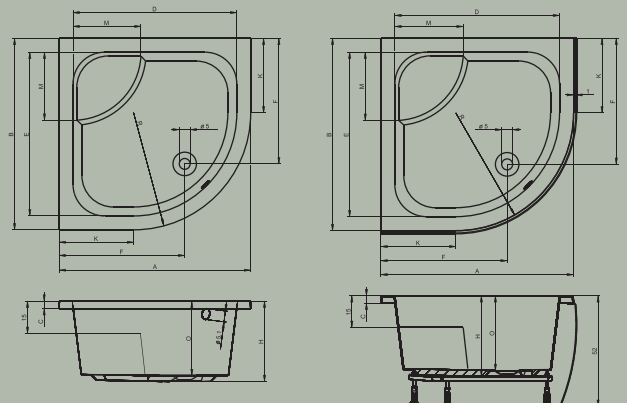

# NEREZOVÉ PODLAHOVÉ ŽLABY ŘADY C

## THE STAINLESS STEEL SHOWER DRAINS C

### ДУШЕВЫЕ ТРАПЫ ИЗ НЕРЖАВЕЮЩЕЙ СТАЛИ СЕРИИ C

Nerezové podlahové žlaby řady C jsou charakterizovány moderním designem a dokonalou funkcí. Základem je nerez ocel o vysoké kvalitě, která se používá pro výrobu samotného sprchového žlabu, vpustí a roštu dle evropských norem. Povrchová úprava nerezových roštů je prováděna kartáčováním do hedvábného lesku. Vnější část zápchového uzávěru je vyrobena z nerez oceli a vnitřní část je vyrobena z polypropylenu.

The Shower Drain C series is characterized by modern design and perfect functionality. The basic is the high quality stainless steel which is used for the production of the shower channel itself, according to the European standards, gully and grating. The foul air trap is made out of polypropylene.

Душевые трапы серии C – характеризуются современным дизайном и наилучшей функциональностью. Основа – высококачественная нержавеющая сталь, которая используется для производства душа. Его канал, согласно европейским стандартам состоит из желоба и решетки.

Затвор неприятного запаха изготовлен из полипропилена.



**S horizontální přírubou**  
With horizontal flange  
С горизонтальным фланцем



**S horizontální a vertikální přírubou**  
With vertical flange  
С вертикальным фланцем



**Bez příruby**  
Without flange  
Без фланца

### Snadné čištění

#### Easy cleaning

#### несложная очистка



Rošty řady C z nerezové oceli mají jedinečný tvar, u kterého je střední část roštu nižší než hrany. To významným způsobem omezuje riziko přetékání vody.

The stainless steel Shower Drain C gratings have a unique shape in which the middle part of the grating is lower than the edges. This reduces the risk of overshooting of water significantly.

Трап из нержавеющей стали серии C имеет уникальную форму, благодаря которой трение в средней части ниже, чем по краям, это значительно сокращает риск утечки воды.



- průtok/flow/протекающее количество/0,95l/s

- průtok u vstupu sprchy/flow at entrance to enclosure/протекающее количество входа в душу/0,5l/s

- průtok proti stěně/flow against wall/протекающее количество у стены души/0,8l/s

# Žlaby s horizontální přírubou

## Shower Drains with horizontal flange

### Душевые трапы с горизонтальным фланцем

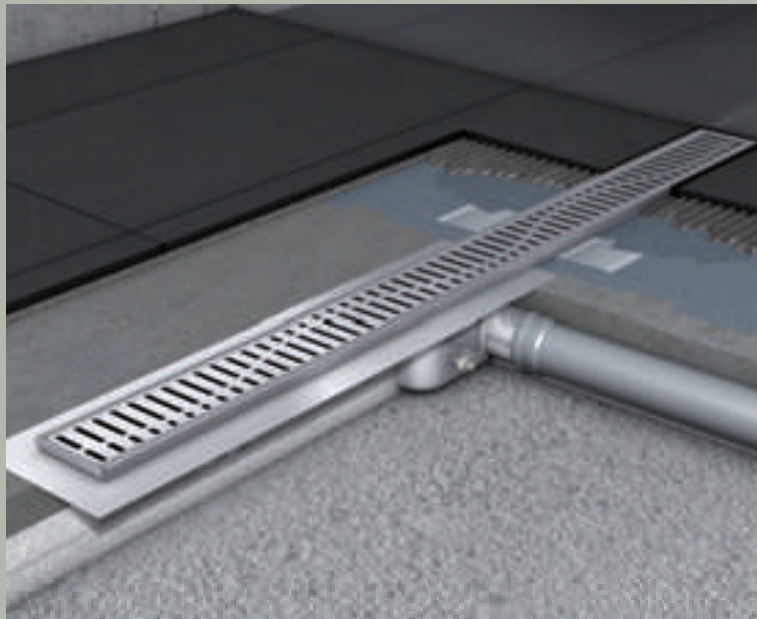

Instalační výška

H - 92 mm se standardním zápachovým uzávěrem (výška vodního sloupce 50 mm)

H - 92 mm with standard FAT (odour seal height 50mm)

H - 92 мм со стандартной толщиной (высота затвора запаха 50 мм)

H - 65 mm se standardním zápachovým uzávěrem (výška vodního sloupce 30 mm)

H - 65 mm with lower FAT (odour seal height 30mm)

H - 65 мм с меньшей толщиной (высота затвора запаха 30 мм)

L1 - délka žlabu bez příruby/length of the drain without flange/длина трапа без фланца

L2 - délka žlabu s přírubou/length of the drain with flange/длина трапа с фланцем

50 mm  
výška pachového uzávěru  
height of FAT  
высота затвора запаха

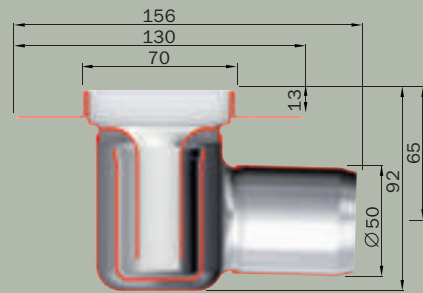

Instalace s horizontální přírubou  
Installation with horizontal flange  
Инсталляция с горизонтальным фланцем

30 mm  
výška pachového uzávěru  
height of FAT  
высота затвора запаха

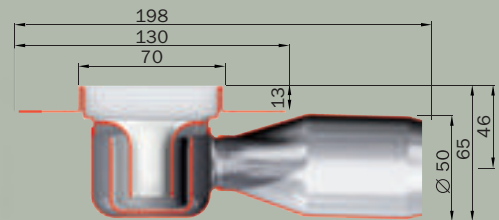

Nízká instalace s horizontální přírubou  
Low installation with horizontal flange  
Низкая инсталляция с горизонтальным фланцем

**Objednací čísla nerezových žlabů řady C s horizontální přírubou (bez roštu)**  
**Order data – Stainless steel drains range C with horizontal flange**  
**Заказные параметры – Трап из нержавеющей стали C с горизонтальным выпуском**

| L <sub>1</sub> | L <sub>2</sub> | 50 mm         | 30 mm         |
|----------------|----------------|---------------|---------------|
| 585            | 645            | AD04058511600 | AD04058511200 |
| 685            | 745            | AD04068511600 | AD04068511200 |
| 785            | 845            | AD04078511600 | AD04078511200 |
| 885            | 945            | AD04088511600 | AD04088511200 |
| 985            | 1045           | AD04098511600 | AD04098511200 |
| 1085           | 1145           | AD04108511600 | AD04108511200 |
| 1185           | 1245           | AD04118511600 | AD04118511200 |

# Rošty k podlahovým žlabům

## Gratings/Решетки

ŘADA C

WAVE



SQUARE



WATER



SLOT



TILE

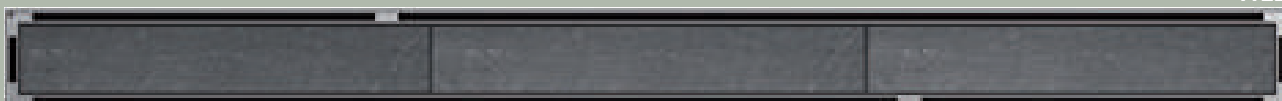

výška dlažby max. 10 mm/height of tile is max. 10 mm/высота плитки макс. 10 мм

SOLID

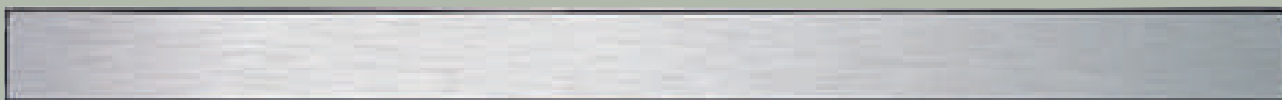

Objednací čísla roštů (bez žlabů)  
Order data – gratings (without drains)  
Заказные параметры – решетки (без трапов)



| Rošt/Grating/Решетка   | $L_1$<br>585 cm | 685 mm        | 785 mm        | 885 mm        |
|------------------------|-----------------|---------------|---------------|---------------|
| Wave jednoduchý rošt   | AE04058514100   | AE04068514100 | AE04078514100 | AE04088514100 |
| Square jednoduchý rošt | AE04058512100   | AE04068512100 | AE04078512100 | AE04088512100 |
| Water jednoduchý rošt  | AE04058516300   | AE04068516300 | AE04078516300 | AE04088516300 |
| Slot jednoduchý rošt   | AE04058511100   | AE04068511100 | AE04078511100 | AE04088511100 |
| Tile jednoduchý rošt   | AE04058513300   | AE04068513300 | AE04078513300 | AE04088513300 |
| Solid                  | AE04058516100   | AE04068516100 | AE04078516100 | AE04088516100 |

| Rošt/Grating/Решетка   | $L_1$<br>985 mm | 1085 mm       | 1185 mm       |
|------------------------|-----------------|---------------|---------------|
| Wave jednoduchý rošt   | AE04098514100   | AE04108514100 | AE04118514100 |
| Square jednoduchý rošt | AE04098512100   | AE04108512100 | AE04118512100 |
| Water jednoduchý rošt  | AE04098516300   | AE04108516300 | AE04118516300 |
| Slot jednoduchý rošt   | AE04098511100   | AE04108511100 | AE04118511100 |
| Tile jednoduchý rošt   | AE04098513300   | AE04108513300 | AE04118513300 |
| Solid                  | AE04098516100   | AE04108516100 | AE04118516100 |

Žlaby s horizontální a vertikální přírubou  
Drains with horizontal and vertical flange  
Трапы с горизонтальным и вертикальным фланцем

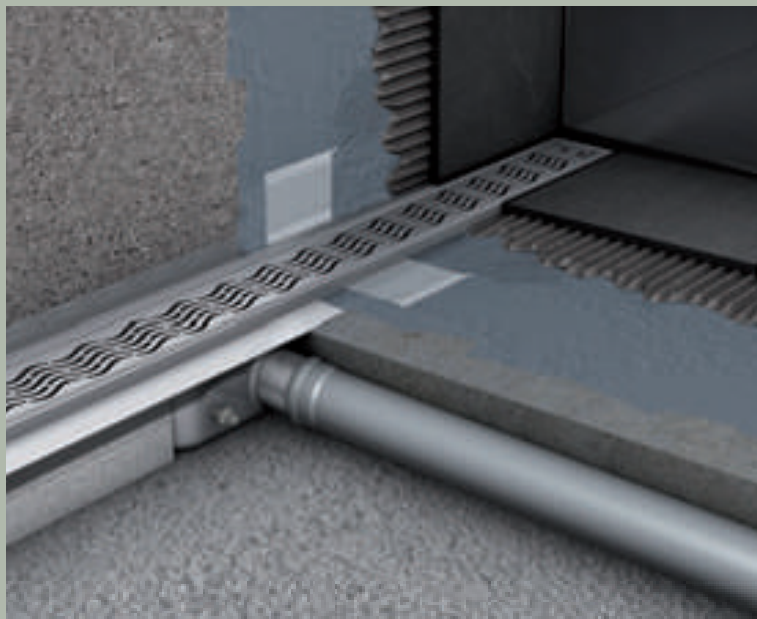

50 mm  
výška pachového uzávěru  
height of FAT  
высота затвора запаха

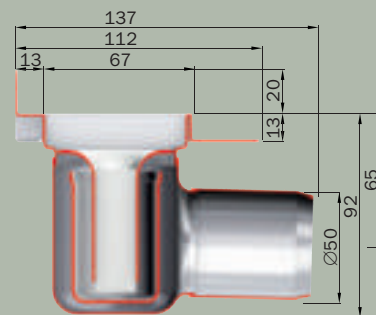

Instalace s horizontální a vertikální přírubou  
Installation with horizontal and vertical flange  
Инсталация с горизонтальным и вертикальным фланцем

30 mm  
výška pachového uzávěru  
height of FAT  
высота затвора запаха

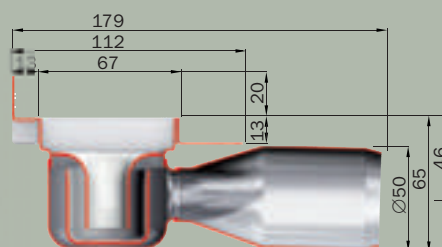

Nízká instalace s horizontální a vertikální přírubou  
Low installation with horizontal and vertical flange  
Низкая инсталляция с горизонтальным и вертикальным фланцем

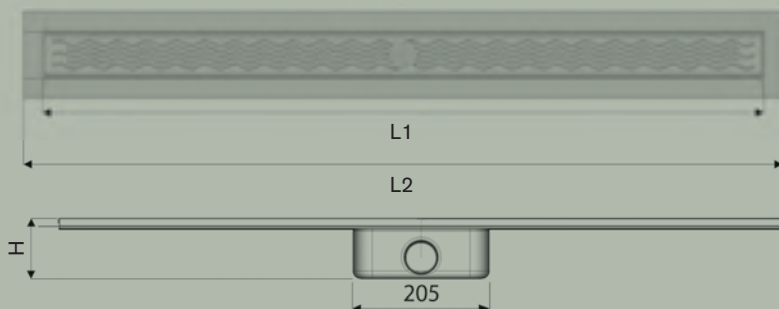

Instalační výška

H - 92 mm se standardním zápachovým uzávěrem (výška vodního sloupce 50 mm)

H - 92 mm with standard FAT (odour seal height 50mm)

H - 92 мм со стандартной толщиной (высота затвора запаха 50 мм)

H - 65 mm se standardním zápachovým uzávěrem (výška vodního sloupce 30 mm)

H - 65 mm with lower FAT (odour seal height 30mm)

H - 65 мм с меньшей толщиной (высота затвора запаха 30 мм)

L1 - délka žlabu bez příruby/length of the drain without flange/длина трапа без фланца

L2 - délka žlabu s přírubou/length of the drain with flange/длина трапа с фланцем

Objednací čísla nerezových žlabů řady C s horizontální a vertikální přírubou (bez roštu)

Order data stainless steel drain range C with horizontal and vertical flange (without grating)

Заказные параметры душевых трапов с горизонтальным и вертикальным фланцем (без решетки)

| L1   | L2   | 50 mm         | 30 mm         |
|------|------|---------------|---------------|
| 585  | 645  | AD04058551600 | AD04058551200 |
| 685  | 745  | AD04068551600 | AD04068551200 |
| 785  | 845  | AD04078551600 | AD04078551200 |
| 885  | 945  | AD04088551600 | AD04088551200 |
| 985  | 1045 | AD04098551600 | AD04098551200 |
| 1085 | 1145 | AD04108551600 | AD04108551200 |
| 1185 | 1245 | AD04118551600 | AD04118551200 |

# Rošty k podlahovým žlabům Gratings/Решетки

ŘADA C

WAVE



SQUARE



WATER



SLOT



TILE

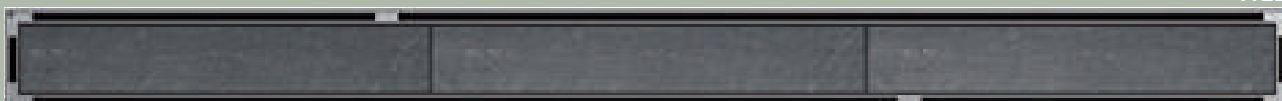

výška dlažby max. 10 mm/height of tile is max. 10 mm/высота плитки макс. 10 мм

SOLID

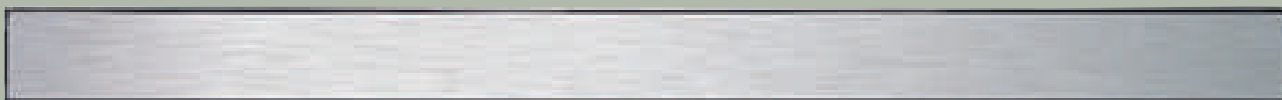

Objednací čísla roštů (bez žlabů)  
Order data – gratings (without drains)  
Заказные параметры – решетки (без трапов)



| Rošt/Grating/Решетка   | $L_1$<br>585 mm | 685 mm        | 785 mm        | 885 mm        |
|------------------------|-----------------|---------------|---------------|---------------|
| Wave jednoduchý rošt   | AE04058514100   | AE04068514100 | AE04078514100 | AE04088514100 |
| Square jednoduchý rošt | AE04058512100   | AE04068512100 | AE04078512100 | AE04088512100 |
| Water jednoduchý rošt  | AE04058516300   | AE04068516300 | AE04078516300 | AE04088516300 |
| Slot jednoduchý rošt   | AE04058511100   | AE04068511100 | AE04078511100 | AE04088511100 |
| Tile jednoduchý rošt   | AE04058513300   | AE04068513300 | AE04078513300 | AE04088513300 |
| Solid                  | AE04058516100   | AE04068516100 | AE04078516100 | AE04088516100 |

| Rošt/Grating/Решетка   | $L_1$<br>985 mm | 1085 mm       | 1185 mm       |
|------------------------|-----------------|---------------|---------------|
| Wave jednoduchý rošt   | AE04098514100   | AE04108514100 | AE04118514100 |
| Square jednoduchý rošt | AE04098512100   | AE04108512100 | AE04118512100 |
| Water jednoduchý rošt  | AE04098516300   | AE04108516300 | AE04118516300 |
| Slot jednoduchý rošt   | AE04098511100   | AE04108511100 | AE04118511100 |
| Tile jednoduchý rošt   | AE04098513300   | AE04108513300 | AE04118513300 |
| Solid                  | AE04098516100   | AE04108516100 | AE04118516100 |

Žlaby bez příruby  
Drains without flange  
Трапы без фланца

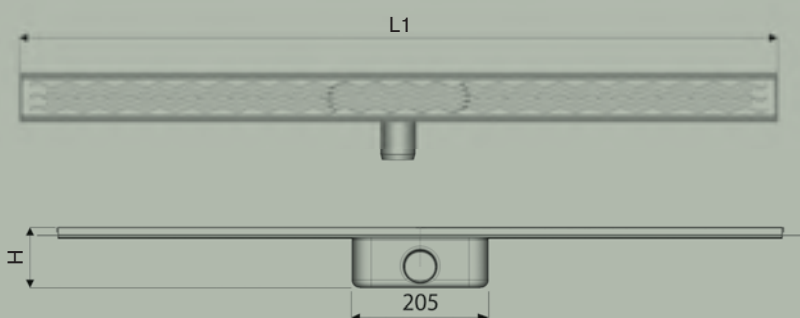
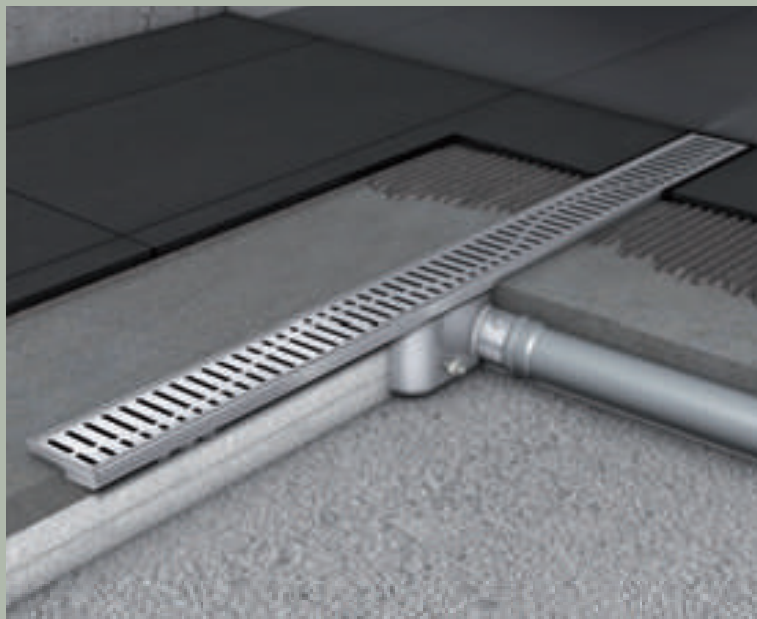

50 mm  
výška pachového uzávěru  
height of FAT  
высота затвора запаха

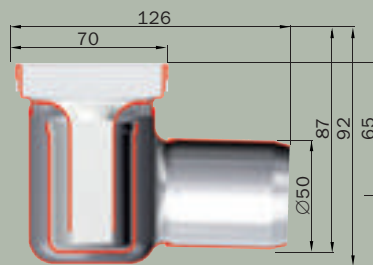

Instalace žlabu bez příruby  
Installation of the drain without flange  
Инсталация трапа без фланца

30 mm  
výška pachového uzávěru  
height of FAT  
высота затвора запаха

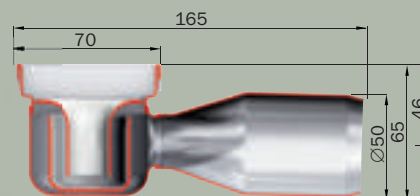

Nízká instalace s vertikální přírubou  
Low installation with vertical flange  
Низкая инсталация трапа без фланца

Instalační výška

H - 92 mm se standardním zápachovým uzávěrem (výška vodního sloupce 50 mm)

H - 92 mm with standard FAT (odour seal height 50mm)

H - 92 мм со стандартной толщиной (высота затвора запаха 50 мм)

H - 65 mm se standardním zápachovým uzávěrem (výška vodního sloupce 30 mm)

H - 65 mm with lower FAT (odour seal height 30mm)

H - 65 мм с меньшей толщиной (высота затвора запаха 30 мм)

L1 - délka žlabu bez příruby/lenght of the drain without flange/длина трапа без фланца

Objednací čísla nerezových žlabů řady C bez příruby (bez roštu)

Order data – Stainless steel drains range C (without gratings)

Заказные параметры душевых трапов C (без решетки)

| L1   | 50 mm         | 30 mm         |
|------|---------------|---------------|
| 585  | AD04058501600 | AD04058501200 |
| 685  | AD04068501600 | AD04068501200 |
| 785  | AD04078501600 | AD04078501200 |
| 885  | AD04088501600 | AD04088501200 |
| 985  | AD04098501600 | AD04098501200 |
| 1085 | AD04108501600 | AD04108501200 |
| 1185 | AD04118501600 | AD04118501200 |

# Rošty k podlahovým žlabům

## Gratings/Решетки

ŘADA C

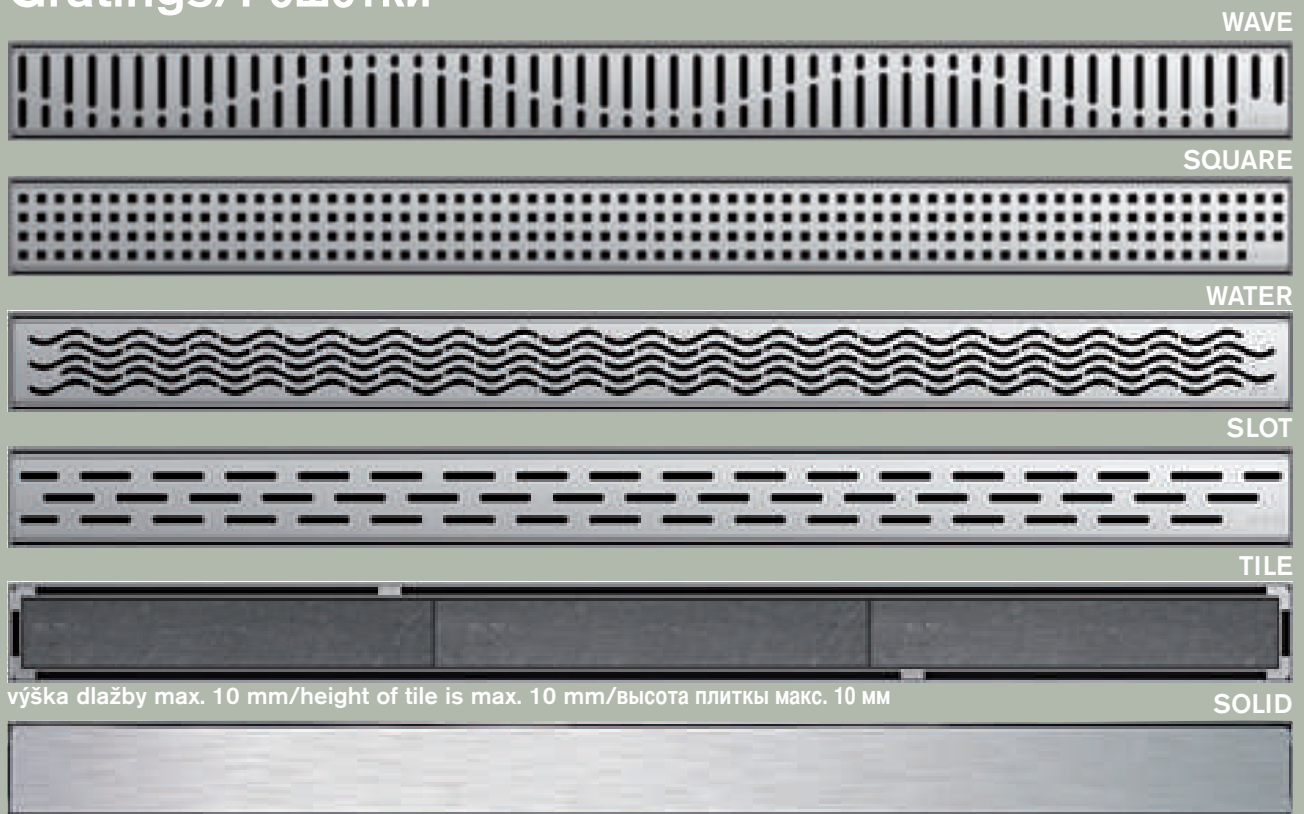

Objednací čísla roštů (bez žlabů)  
Order data – gratings (without drains)  
Заказные параметры – решетки (без трапов)



| Rošt/Grating/Решетка   | $L_1$<br>585 mm | 685 mm        | 785 mm        | 885 mm        |
|------------------------|-----------------|---------------|---------------|---------------|
| Wave jednoduchý rošt   | AE04058514100   | AE04068514100 | AE04078514100 | AE04088514100 |
| Square jednoduchý rošt | AE04058512100   | AE04068512100 | AE04078512100 | AE04088512100 |
| Water jednoduchý rošt  | AE04058516300   | AE04068516300 | AE04078516300 | AE04088516300 |
| Slot jednoduchý rošt   | AE04058511100   | AE04068511100 | AE04078511100 | AE04088511100 |
| Tile jednoduchý rošt   | AE04058513300   | AE04068513300 | AE04078513300 | AE04088513300 |
| Solid                  | AE04058516100   | AE04068516100 | AE04078516100 | AE04088516100 |

| Rošt/Grating/Решетка   | $L_1$<br>985 mm | 1085 mm       | 1185 mm       |
|------------------------|-----------------|---------------|---------------|
| Wave jednoduchý rošt   | AE04098514100   | AE04108514100 | AE04118514100 |
| Square jednoduchý rošt | AE04098512100   | AE04108512100 | AE04118512100 |
| Water jednoduchý rošt  | AE04098516300   | AE04108516300 | AE04118516300 |
| Slot jednoduchý rošt   | AE04098511100   | AE04108511100 | AE04118511100 |
| Tile jednoduchý rošt   | AE04098513300   | AE04108513300 | AE04118513300 |
| Solid                  | AE04098516100   | AE04108516100 | AE04118516100 |

# NEREZOVÉ PODLAHOVÉ ŽLABY ŘADY E THE STAINLESS STEEL SHOWER DRAINS E ДУШЕВЫЕ ТРАПЫ ИЗ НЕРЖАВЕЮЩЕЙ СТАЛИ СЕРИИ E

Řešení žlabů E jsou řešení, která inspirují kreativní plánování koupelen. Tato řešení však mohou být především přizpůsobena na každý požadovaný design.

Shower drain solutions inspire a creative bathroom planning. Above all, however, they can be adapted to every desired design.

Решение трапов типа E вдохновляют творчески планировать ванную. Эти решения однако могут быть прежде всего приспособлены к каждому выбору дизайна.



**V liniovém odvodnění**  
**Linear Solution**  
**Ровный**



**S mřížkou**  
**v rohovém odvodnění**  
**Corner solution**  
**Угловый с решеткой**



**Osvětlení/Lightline/Освещение**  
Sprchový žlab pro řady E je volitelně k dispozici s osvětlením pro liniová, a rohová odvodnění

The shower drain E is available optionally with illumination for straight and corner designs.

Душевый трап типа E можно выбрать с освещением для ровных и угловых

## Kvalita nerezových žlabů

Jednotlivé komponenty žlabů řady E jsou navzájem pevně svařeny. Z tohoto důvodu nemůže dojít k prosáknutí, a to ani v důsledku extrémního namáhání, ani z důvodu opotřebení.

## Quality

The components of the shower drains are firmly welded with each other. Therefore, leakages cannot develop, neither by extreme stress nor by wear.

## Качество нержавеющей трапов

Отдельные компоненты трапов E прочно сварены между собой. Поэтому не могут треснуть и даже в результате экстремальной нагрузки или из-за износа.



## Velké čisticí možnosti

Po odstranění zápachového uzávěru s dvojitým tělesem získáte přístup k celému odpadnímu potrubí. Z tohoto důvodu je pak možno bez problémů vložit do systému čisticí spirálu v případě zanesení potrubí.

## Large cleaning section

After removing the dual-body odour seal, the entire pipe section is available. For this reason, a cleaning spiral can be inserted without problems in the case of pipe blockage.

## Чистка

После отстранения противозапахового затвора с двойным телом найдёте доступ к сточной трубе. Потом можно вложить в систему очищающую спираль, в случаи загрязнения трубопровода.

- průtok/flow/протекающее количество/0,8l/s
- průtok u vstupu sprchy/flow at entrance to enclosure/протекающее количество входа в душу/0,4l/s
- průtok proti stěně/flow against wall/протекающее количество у стены души/0,6l/s

# Nerezové podlahové žlaby

## The stainless steel Shower Drains

### Душевые трапы из нержавеющей стали

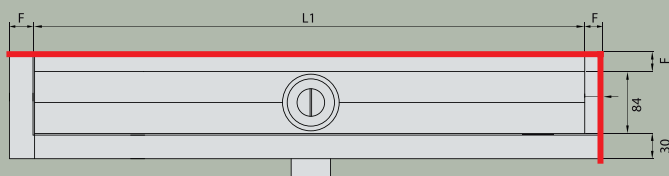
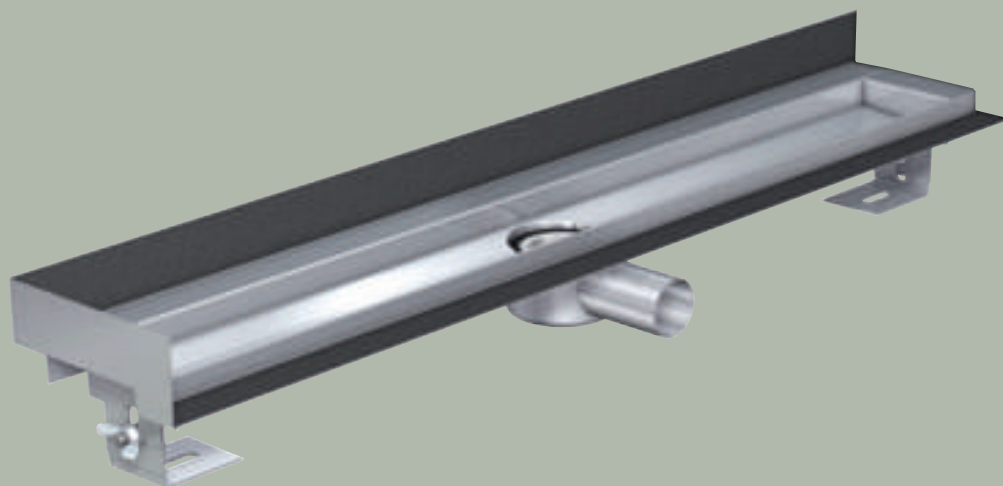

H = 105 až 160 mm s výškou pachového uzávěru 50 mm  
 H = 79 až 134 mm s výškou pachového uzávěru 25 mm  
 Rozměrové výkresy uvádějí příklady vertikálních přírub na zadní a pravé straně

H = 105 až 160 mm with odou seal height 50 mm  
 H = 79 up to 134 mm with odou seal height 25 mm  
 The dimensional drawing exemplifies vertical flanges on rear and rightside

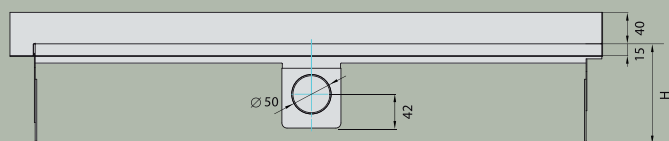

H = 105 до 160 мм с высотой затвора запаха 50 мм  
 H = 79 до 134 мм с высотой затвора запаха 25 мм  
 На технических рисунках показываются произведения с вертикальным фланцем на задней и правой стороне

| Příruba/Flange/фланец                  | F  |
|--|----|
| Horizontalní/horizontal/горизонтальный | 30 |
| Vertikální/vertical/вертикальный       | 20 |

Typ vertikální příruby

Type of the vertical flange

Произведение вертикального фланца

| L1 | č. 50 mm | 25 mm |
|----|----------|-------|
| L1 | č. 50 mm | 25 mm |
| L1 | č. 50 mm | 25 mm |

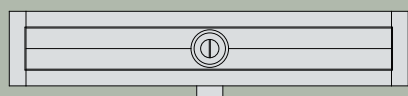

žádná/none/никакой

|      |               |               |
|------|---------------|---------------|
| 700  | AD01070011600 | AD01070011100 |
| 800  | AD01080011600 | AD01080011100 |
| 900  | AD01090011600 | AD01090011100 |
| 1000 | AD01100011600 | AD01100011100 |
| 1200 | AD01120011600 | AD01120011100 |

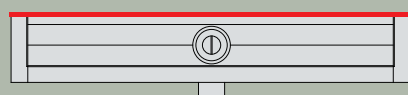

zadní/rear/задний

|      |               |               |
|------|---------------|---------------|
| 700  | AD01070015600 | AD01070015100 |
| 800  | AD01080015600 | AD01080015100 |
| 900  | AD01090015600 | AD01090015100 |
| 1000 | AD01100015600 | AD01100015100 |
| 1200 | AD01120015600 | AD01120015100 |

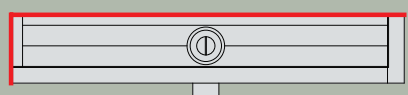

zadní levá/rear and left hand/задний левой

|      |               |               |
|------|---------------|---------------|
| 700  | AD01070016600 | AD01070016100 |
| 800  | AD01080016600 | AD01080016100 |
| 900  | AD01090016600 | AD01090016100 |
| 1000 | AD01100016600 | AD01100016100 |
| 1200 | AD01120016600 | AD01120016100 |

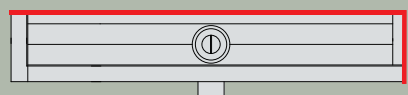







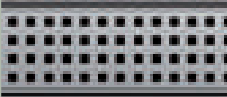

zadní pravá/rear and right hand/задний правой

|      |               |               |
|------|---------------|---------------|
| 700  | AD01070017600 | AD01070017100 |
| 800  | AD01080017600 | AD01080017100 |
| 900  | AD01090017600 | AD01090017100 |
| 1000 | AD01100017600 | AD01100017100 |
| 1200 | AD01120017600 | AD01120017100 |

# Designové rošty z nerez oceli/Design gratings

ŘADA E

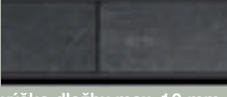
## from stainless steel/Дизайновые решетки из нержавеющей стали

| Design  | L1      | pro žlaby řady E<br>for drains E<br>для трапов E | pro rohový žlab<br>for corner drain<br>для углового трапа | pro systémové desky<br>for showerboards<br>для системного отвода воды |
|---|---------|--|---|---|
|    | 398x398 | -  | AE02039804200   | -   |
|   | 700     | AE01070004100                                    | -   | AE01070004100   |
|   | 800     | AE01080004100                                    | -   | AE01080004100   |
|   | 900     | AE01090004100                                    | -   | AE01090004100   |
|   | 1000    | AE01100004100                                    | -   | -   |
|   | 1100    | -  | -   | AE01110004100   |
|   | 1200    | AE01120004100                                    | -   | -   |
|    | 398x398 | -  | AE02039802200   | -   |
|   | 700     | AE01070002100                                    | -   | AE01070002100   |
|   | 800     | AE01080002100                                    | -   | AE01080002100   |
|   | 900     | AE01090002100                                    | -   | AE01090002100   |
|   | 1000    | AE01100002100                                    | -   | -   |
|   | 1100    | -  | -   | AE01110002100   |
|   | 1200    | AE01120002100                                    | -   | -   |
|    | 398x398 | -  | AE02039801200   | -   |
|   | 700     | AE01070001100                                    | -   | AE01070001100   |
|   | 800     | AE01080001100                                    | -   | AE01080001100   |
|   | 900     | AE01090001100                                    | -   | AE01090001100   |
|   | 1000    | AE01100001100                                    | -   | -   |
|   | 1100    | -  | -   | AE01110001100   |
|   | 1200    | AE01120001100                                    | -   | -   |
|    | 398x398 | -  | AE02039809200   | -   |
|   | 700     | AE01070009100                                    | -   | AE01070009100   |
|   | 800     | AE01080009100                                    | -   | AE01080009100   |
|   | 900     | AE01090009100                                    | -   | AE01090009100   |
|   | 1000    | AE01100009100                                    | -   | -   |
|   | 1100    | -  | -   | AE01110009100   |
|   | 1200    | AE01120009100                                    | -   | -   |
|  | 398x398 | -  | AE02039810200   | -   |
|   | 700     | AE01070010100                                    | -   | AE01070010100   |
|   | 800     | AE01080010100                                    | -   | AE01080010100   |
|   | 900     | AE01090010100                                    | -   | AE01090010100   |
|   | 1000    | AE01100010100                                    | -   | -   |
|   | 1100    | -  | -   | AE01110010100   |
|   | 1200    | AE01120010100                                    | -   | -   |
|  | 398x398 | -  | AE02039811200   | -   |
|   | 700     | AE01070011100                                    | -   | AE01070011100   |
|   | 800     | AE01080011100                                    | -   | AE01080011100   |
|   | 900     | AE01090011100                                    | -   | AE01090011100   |
|   | 1000    | AE01100011100                                    | -   | -   |
|   | 1100    | -  | -   | AE01110011100   |
|   | 1200    | AE01120011100                                    | -   | -   |
|  | 398x398 | -  | AE02039812200   | -   |
|   | 700     | AE01070012100                                    | -   | AE01070012100   |
|   | 800     | AE01080012100                                    | -   | AE01080012100   |
|   | 900     | AE01090012100                                    | -   | AE01090012100   |
|   | 1000    | AE01100012100                                    | -   | -   |
|   | 1100    | -  | -   | AE01110012100   |
|   | 1200    | AE01120012100                                    | -   | -   |
|  | 398x398 | -  | AE02039803200   | -   |
|   | 700     | AE01070003100                                    | -   | AE01070003100   |
|   | 800     | AE01080003100                                    | -   | AE01080003100   |
|   | 900     | AE01090003100                                    | -   | AE01090003100   |
|   | 1000    | AE01100003100                                    | -   | -   |
|   | 1100    | -  | -   | AE01110003100   |
|   | 1200    | AE01120003100                                    | -   | -   |
|  | 398x398 | -  | -   | -   |
|   | 700     | AE01070016100                                    | -   | -   |
|   | 800     | AE01080016100                                    | -   | -   |
|   | 900     | AE01090016100                                    | -   | -   |
|   | 1000    | AE01100016100                                    | -   | -   |
|   | 1100    | -  | -   | -   |
|   | 1200    | AE01120016100                                    | -   | -   |

výška dlažby max. 10 mm  
height of tile is max. 10 mm  
высота плитки макс. 10 мм

Skleněné rošty  
Glass gratings  
Стеклянные решетки

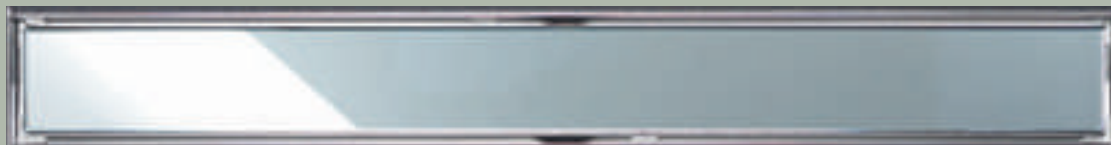

Design

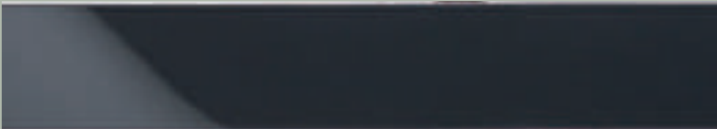
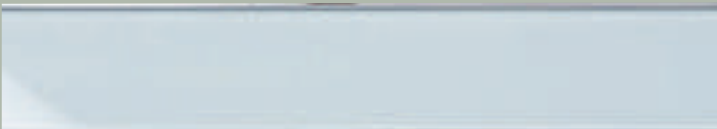
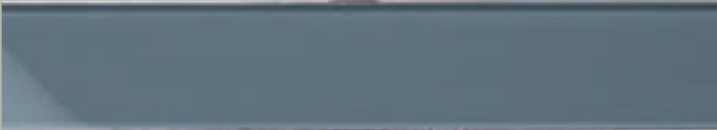
|  |                | <i>L1</i>          |
|--|----------------|--------------------|
|   | sklo, černé    | 700 AE01070013100  |
|  | glass, black   | 800 AE01080013100  |
|  | стекло, чёрное | 900 AE01090013100  |
|  |                | 1000 AE01100001300 |
|  |                | 1200 AE01120001300 |
|   | sklo, bílé     | 700 AE01070014100  |
|  | glass, white   | 800 AE01080014100  |
|  | стекло, белое  | 900 AE01090014100  |
|  |                | 1000 AE01100014100 |
|  |                | 1200 AE01120014100 |
|  | sklo, šedé     | 700 AE01070015100  |
|  | glass, grey    | 800 AE01080015100  |
|  | стекло, серые  | 900 AE01090015100  |
|  |                | 1000 AE01100015100 |
|  |                | 1200 AE01120015100 |



# Rohový žlab

## The corner shower drain

### Угловой трап

#### Popis výrobku

- sprchový žlab jako rohové odvodnění pro sprchový prostor, vhodné pro všechny systémy nátrubků a hrdel násuvného typu
- instalační výška: 105–160 mm
- standardizované konstrukční parametry odtoku: 0,4 l/s
- šířka žlabu: 84 mm
- délka ramene: 400 mm
- žlab s vnitřním spádem
- odstranitelný zápachový uzávěr tvořený dvěma sifony z nerezové oceli
- sklon: 1,5°
- elektrolyticky leštěný povrch
- příruba pro stěrkovou izolaci, se stěnovým okrajem u obou předních stran

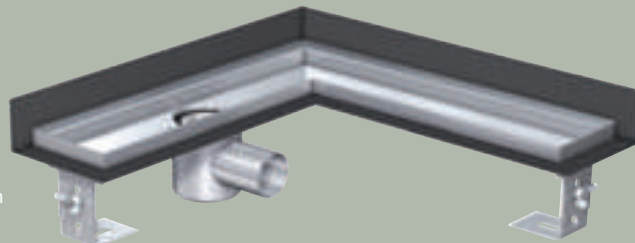

#### Article description

- drainage channel as corner solution for the shower area, suitable for all push-fit socket systems
- installation height: 105–160 mm
- full stainless steel channel
- standard design outflow capacity: 0,4 l/s
- channel width: 84 mm
- leg length: 400 mm
- drain suitable for all push-fit pipe socket systems
- channel body with lateral slope
- removable dual-body osour seal of stainless steel
- inclination 1,5°
- electro-polished surface
- surrounding, integral thin bed flange with wall lip at both legs

Délka  
Lenght  
Длина  
398x398

obj. č.  
art. no.  
Код для заказа  
AD02039851600

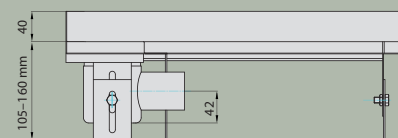

#### Описание издания

- угловой трап для углового стока из душевого пространства, пригоден для всех систем патрубков
- высота установки: 105–160 мм
- лоток изготовлен из нержавеющей стали
- стандартные параметры конструкции для стока: 0,4 л/сек
- ширина лотка: 84 мм
- длина плеча: 400 мм
- сток DN 50 пригоден для всех систем патрубков и надвигаемых раструбов
- лоток с внутренним уклоном
- съёмный грязеуловитель от запаха, состоящий из двух сифонов из нержавеющей стали
- уклон: 1,5°
- электролитическая полировка поверхности
- уплотнительный фланец для бесшовной изоляции, со сплошным краем с двух передних сторон

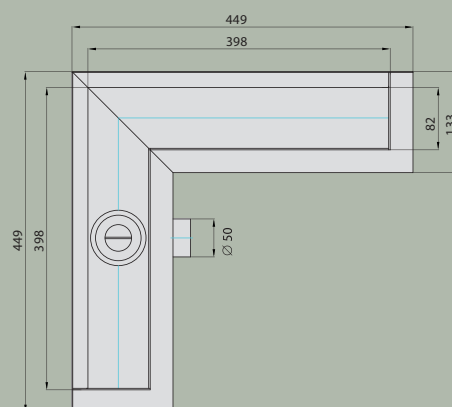

#### Výhody výrobku

- plně svařované těleso z nerezové oceli, žádné riziko průsaků
- elektrolyticky leštěné tělo pro skvělý vzhled a snadné čištění
- vyrovnávací nohy pro snadnou instalaci
- široký sortiment roštů z nerezové oceli

#### Product advantages

- full welded stainless steel body, no risk of leakage
- electro-polished body and gratings for great looks and easy cleaning
- levelling feet for easy installation
- wide range of stainless steel gratings

#### Преимущества издания

- цельносварной блок из нержавеющей стали, полное отсутствие риска просачивания
- электролитическая полировка поверхности для достижения эстетичности вида, простота чистки
- регуляторы высоты для простоты установки
- предусмотрена поставка с освещением
- широкий ассортимент решеток из нержавеющей стали

# Osvětlení žlabů

## Lightline - illumination for shower drains

### Освещение душевых трапов

#### Popis výrobku

- Osvětlení pro sprchové žlaby řady E
- vhodné pro rošty v provedení nerez ocel, nevhodné pro skleněné a minerální mřížky
- automatické rozsvícení při styku s vodou
- skládá se z těchto prvků: 2 moduly LED s možností opětovného nabití a 1 nízkonapěťová nabíječka
- modul LED je vhodný pro použití pod vodou



#### Article description

- Illumination kit for E shower channels
- suitable for stainless steel design gratings, not suitable for glass and mineral gratings
- will light automatically when in contact with water
- consisting of: 2 rechargeable LED modules and 1 recharger low voltage
- LED module suitable for underwater use
- available only for ShowerDrain E solutions

#### Описание изделия

- освещение для душевых трапов серии E
- удобно для решеток из нержавеющей стали, не подходит для стеклянных и минеральных решеток
- автоматическое включение освещения при контакте с водой
- состоит из следующих элементов: 2 LED-модуля с возможностью повторной зарядки и одно зарядное устройство низкого напряжения
- модуль LED пригоден для использования под водой
- предусмотрено только для серии E



Modrá/Blue/Синий

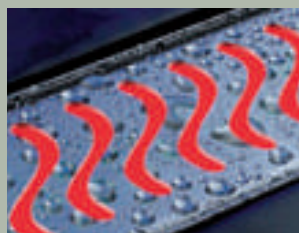

Červená/Red/Красный



Zelená/Green/Зеленый

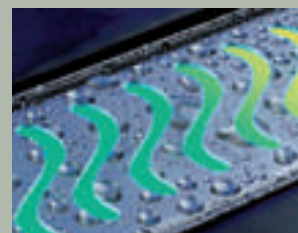

Duhová/Rainbow/Радужный

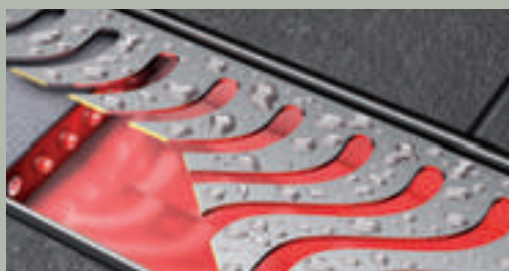

Osvětlení Lightline (2 moduly LED a nabíječka)  
Illumination kit (2 LED modules and recharger)

Освещение Lightline (2 LED – модуля и зарядное устройство)



| Design         | obj. č.        |
|----------------|----------------|
| Design         | art. no.       |
| Дизайн         | Код для заказа |
| Modrá/Blue     | AF01571020501  |
| Červená/Red    | AF01571020502  |
| Zelená/Green   | AF01571020503  |
| Duhová/Rainbow | AF01571020504  |

# RUG Self - žlab s přírubou

## RUG Self - drain with flange

### RUG Self - трап с решеткой

Plastová odtoková výpust s pachovým uzávěrem H=87mm

Plastic drainage outlet with odour seal H=87mm

Пластиковый отвод с антизапаховым затвором H=87mm

Žlab s roštem z nerezové oceli - jen design Shark  
 Shower drain from stainless steel - only design Shark  
 Трап с решеткой - нержавеющая сталь

| L1  | L2   | Objednací číslo |
|-----|------|-----------------|
| 683 | 744  | AD06068311640   |
| 783 | 844  | AD06078311640   |
| 883 | 944  | AD06088311640   |
| 983 | 1044 | AD06098311640   |



Design Shark

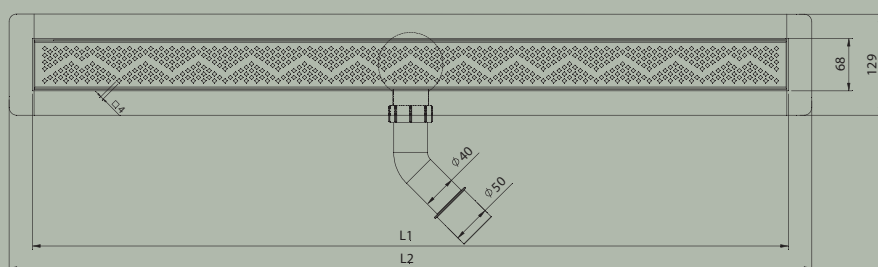

- průtok u vstupu sprchy/flow at entrance to enclosure/протекающее количество входа в душу 0,55l/s

- průtok proti stěně/flow against wall/протекающее количество у стены души 0,35l/s

# Nerezový štěrbinový žlab

## The stainless slot drain

### Нержавеющий щелевой трап

ŘADA SE

Se zadní vertikální přírubou  
With rear vertical flange  
задний вертикальный фланец



|      |      | Instalační výška H |                 |
|------|------|--------------------|-----------------|
|      |      | 105-160 mm         | 79-134 mm       |
| L1   | L2   | Objednací číslo    | Objednací číslo |
| 700  | 760  | AD05070091600      | AD05070091100   |
| 800  | 860  | AD05080091600      | AD05080091100   |
| 900  | 960  | AD05090091600      | AD05090091100   |
| 1000 | 1060 | AD05100091600      | AD05100091100   |
| 1200 | 1260 | AD05120091600      | AD05120091100   |

H = 105 až 160 mm s výškou pachového uzávěru 50 mm  
H = 79 až 134 mm s výškou pachového uzávěru 25 mm

H = 105 až 160 mm with odour seal height 50 mm  
H = 79 up to 134 mm with odour seal height 25 mm

H = 105 до 160 мм с высотой затвора запаха 50 мм  
H = 79 до 134 мм с высотой затвора запаха 25 мм

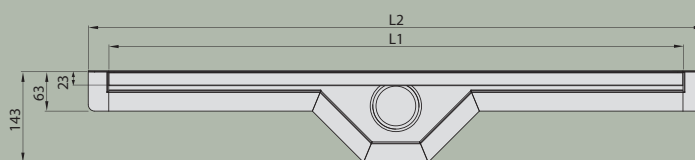
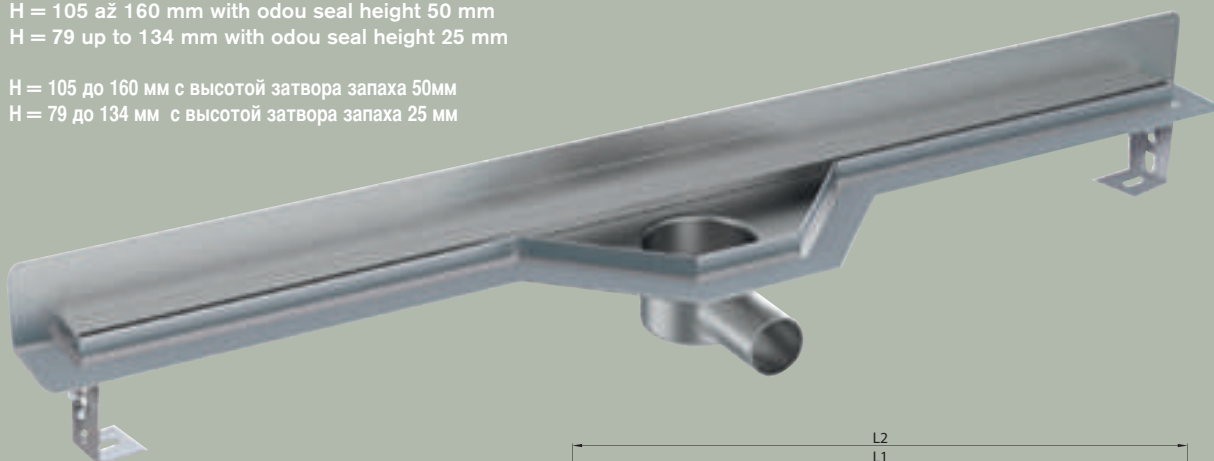

### Designový kryt/Design grating/Дизайновые решетки

**TILE** - pro dlažbu max.10mm/for tile max.10mm/для плиток макс. 10мм



**SOLID**



| šířka (mm) | délka (mm) | Objednací číslo     |
|------------|------------|---------------------|
| 72         | 208        | TILE AE05020875100  |
| 72         | 208        | SOLID AE05020876100 |

- průtok u vstupu sprchy/flow at entrance to enclosure/протекающее количество входа в душу 0,5l/s
- průtok proti stěně/flow against wall/протекающее количество у стены души 0,3l/s





# ПАРНИ́ КАБИНЫ

STEAM CABINS/ПАРОВЫЕ КАБИНЫ

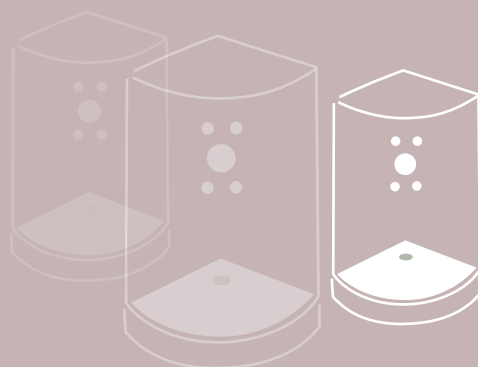

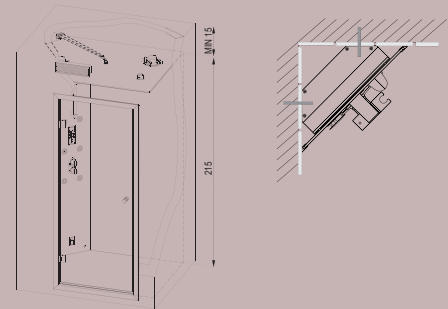
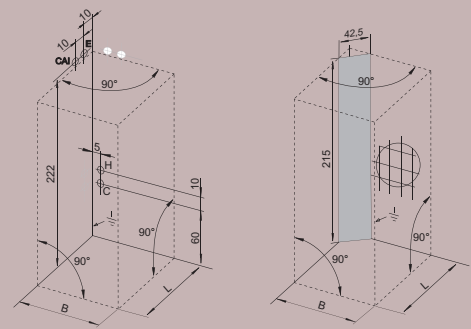
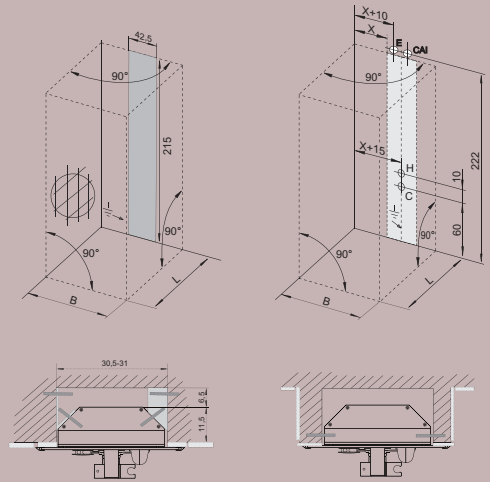

Technický panel mint nebo černý/Technical panel mint or black/Душевая стойка салатная или черная  
 \* přívod el. energie 400 V, 2-fázové napětí pro generátor páry 5,8 kW  
 / must be el. power 400 V and 2 phase voltage for the steam generator 5.8 kW  
 /подвод электрической энергии 400 В, двухфазное напряжение для генераторов пара 5,8 кВт

Dveře nejsou součástí parní kabiny/doors are not included in steam cabine/  
 двери не включены в паровую кабину

Minimální objem vnitřního prostoru parní kabiny je 1,4m<sup>3</sup>  
 /Minimum inside space of the steam cabine is 1,4m<sup>3</sup>  
 /Минимальное внутреннее пространство паровой кабины – 1,4 м<sup>3</sup>  
 Maximální objem vnitřního prostoru parní kabiny je 4m<sup>3</sup>  
 /Maximum inside space of the steam cabine is 4m<sup>3</sup>  
 /Максимальное внутреннее пространство паровой кабины – 4 м<sup>3</sup>

C - přívod studené vody / cold water supply / подвод холодной воды  
 H - přívod teplé vody / hot water supply / подвод горячей воды  
 E - přívod elektrické energie 400V - / power wiring 400V -  
 / подвод электричества 400В\*  
 ⚡ - zemnicí vodič / ground conductor / заземляющий провод  
 CAI - externí anténa  
 / external antenna  
 / внешняя антенна



**PROF**



vybavení za příplatek / option /опция  
 rozměry / size / размер 36x35 cm  
 nosnost / maximum load / Максимальный вес 130 kg  
 Nesmí být použito pro porobetonové zdi/  
 it can not be used for aeroconcrete walls/  
 Не разрешается использовать для пенобетонных стен

# MAJESTIC 90x90 cm 100x90 cm

PROF



**MAJESTIC BLACK A**

A - výška vaničky/height of shower tray/высота поддона 4,5 cm;  
 B - výška vaničky/height of shower tray/высота поддона 14,0 cm  
 Technický panel mint nebo černý/Technical panel mint or black/Душевая стойка салатная или черная



**MAJESTIC MINT B**



vybavení za příplatek / option / опция  
 rozměry / size / размер 36x35 cm  
 nosnost / maximum load / Максимальный вес 130 kg

Nesmí být použito pro porobetonové zdi/it can not be used for aeroconcrete walls/  
 Не разрешается использовать для пенобетонových стен



**PROF**

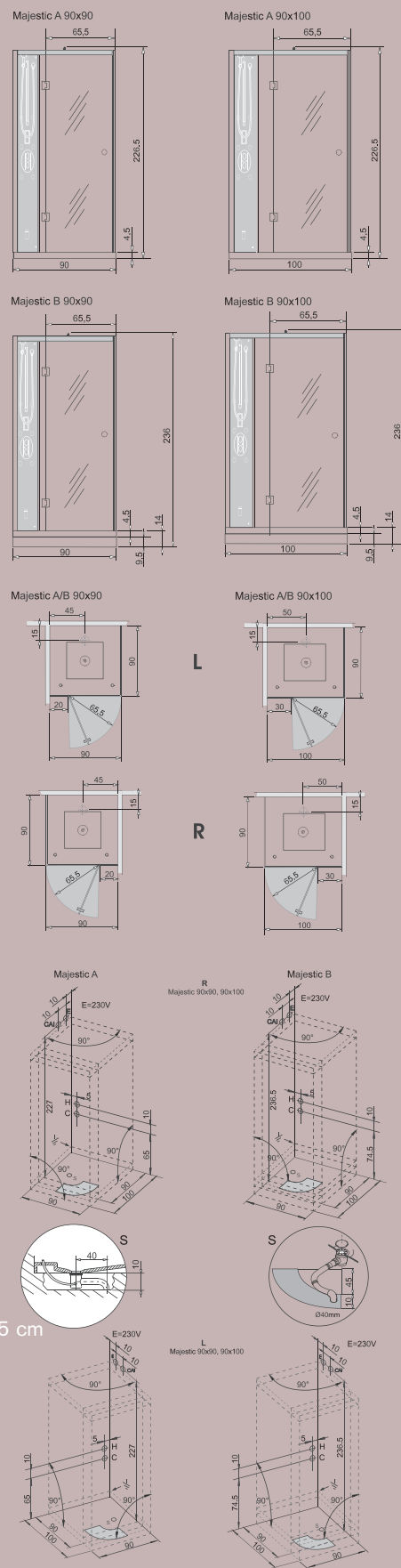

C - přívod studené vody / cold water supply / подвод холодной воды  
 H - přívod teplé vody / hot water supply / подвод горячей воды  
 E - přívod elektrické energie 230V~ / power wiring 230V~ / подвод электричества 230В  
 ⊥ - zemní vodič / ground conductor / заземляющий провод  
 CAI - externí anténa / external antenna / внешняя антенна

Парні kabiny/Steam cabins/Ларовые кабинны

# MAJESTIC \*120x90 cm \*140x90 cm

PROF

Рамі кабіну/Steam cabins/Паровые кабины



MAJESTIC BLACK B

A - výška vaničky/height of shower tray/высота поддона 4,5 cm  
 B - výška vaničky/height of shower tray/высота поддона 14,0 cm  
 Technický panel mint nebo černý/Technical panel mint or black/Душевая стойка салатная или черная  
 \* přívod el. energie 400 V, 2-fázové napětí pro generátor páry 5,8 kW  
 / must be el. power 400 V and 2 phase voltage for the steam generator 5.8 kW  
 /подвод электрической энергии 400 В, двухфазное напряжение для генераторов пара 5,8 кВт



vybavení za příplatek / option  
 /опция  
 rozměry / size / размер 36x35 cm  
 nosnost / maximum load /  
 Максимальный вес 130 kg  
 Nesmí být použito pro  
 porobetonové zdi/it can not be  
 used for aeroconcrete walls/  
 Не разрешается использовать для  
 пенобетонных стен



PROF

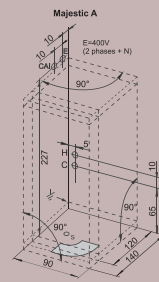
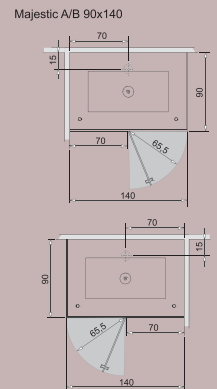
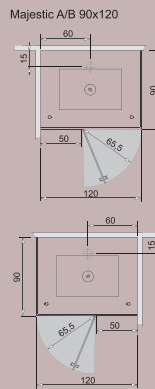
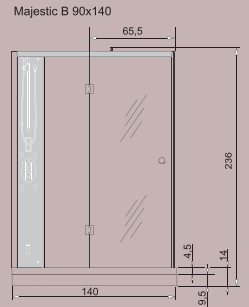
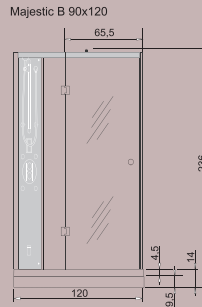
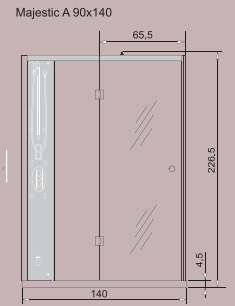
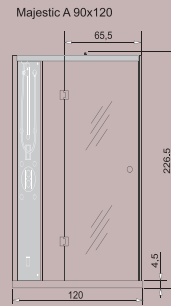

R Majestic 90x120, 90x140

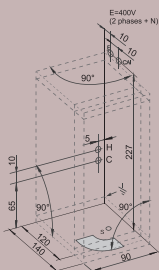
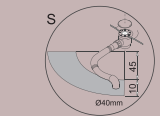
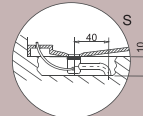
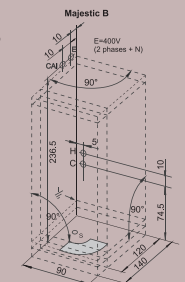

L Majestic 90x120, 90x140

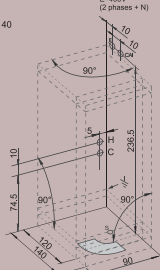

C - přívod studené vody / cold water supply / подвод холодной воды  
 H - přívod teplé vody / hot water supply / подвод горячей воды  
 E - přívod elektrické energie 400V~ / power wiring 400V~  
 / подвод электричества 400В\*  
 ⊥ - zemnicí vodič / ground conductor / заземляющий провод  
 CA1 - externí anténa  
 / external antenna  
 / внешняя антенна



**MEMPHIS A**

A - výška vaničky/height of shower tray/высота поддона 5,5 cm;  
 B - výška vaničky/height of shower tray/высота поддона 14,5 cm

\*\* sprchová vanička + horní kryt - litý mramor / shower tray + cover - synthetic marble  
 / душевой поддон + верхняя крышка - литой мрамор



AS01105

vybavení za příplatek  
 / option / опция

rozměry / size / размер 36x29 cm

nosnost / maximum load

/ Максимальный вес 200 kg

Memphis A

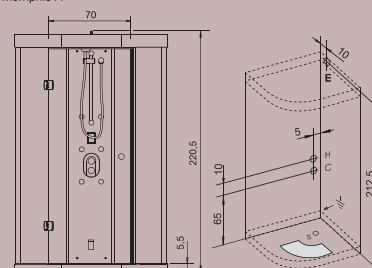

Memphis B

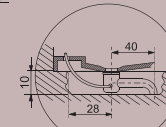
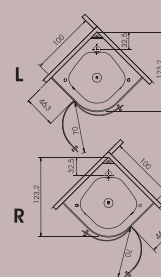
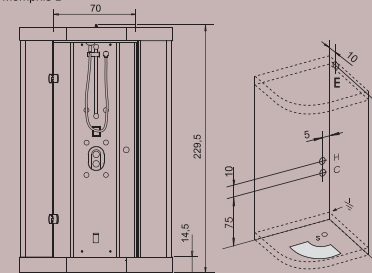

Memphis A

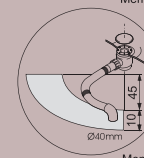

Memphis B

C - přívod studené vody / cold water supply / подвод холодной воды  
 H - přívod teplé vody / hot water supply / подвод горячей воды  
 E - přívod elektrické energie 230V~ / power wiring 230V~  
 / подвод электричества 230В  
 ⊕ - zemnicí vodič / ground conductor / заземляющий провод

# NEVADA 90x90 cm \*100x100 cm \*120x120 cm

PROF

Рамі kabiny/Steam cabins/Паровые кабины



NEVADA B

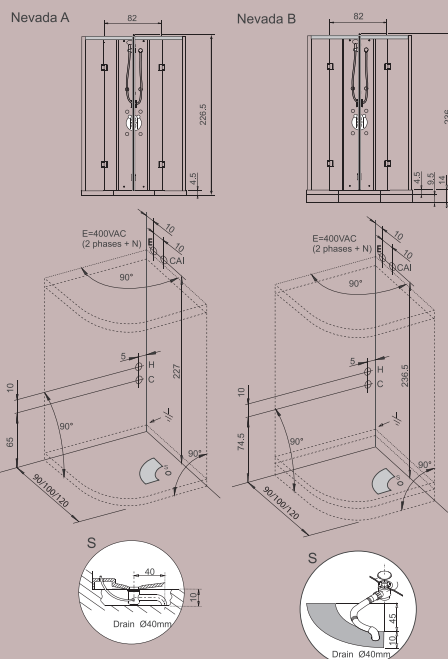

Nevada A/B

90x90

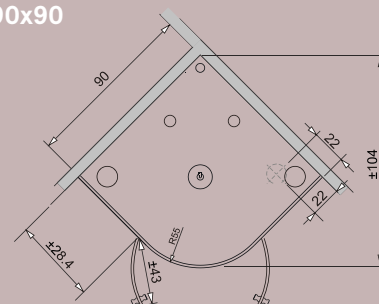

100x100

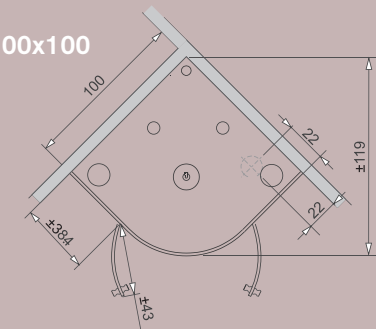

120x120

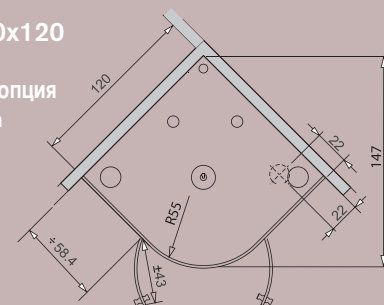

A - výška vaničky/height of shower tray/высота поддона 4,5 cm;  
 B - výška vaničky/height of shower tray/высота поддона 14,0 cm  
 Technický panel mint nebo černý/Technical panel mint or black/Душевая стойка салатная или черная  
 \* přívod el. energie 400 V, 2-fázové napětí pro generátor páry 5,8 kW  
 / must be el. power 400 V and 2 phase voltage for the steam generator 5.8 kW  
 /подвод электрической энергии 400 В, двухфазное напряжение для генераторов пара 5,8 кВт



vybavení za příplatek / option / опция  
 rozměry / size / размер 36x35 cm  
 nosnost / maximum load /  
 Максимальный вес 130 kg

Nesmí být použito pro porobetonové zdi/it can not be used for aerobeton walls/  
 Не разрешается использовать для пенобетонных стен



NEVADA A



PROF

C - přívod studené vody / cold water supply / подвод холодной воды  
 H - přívod teplé vody / hot water supply / подвод горячей воды  
 E - přívod elektrické energie 230V~ / power wiring 230V~  
 / подвод электричества 230В  
 ⊕ - zemnicí vodič / ground conductor / заземляющий провод  
 CAI - externí anténa / external antenna / внешняя антенна

# PRIMO 95x95 cm

EASY/PROF

ČTVRTKRUH/ROUND/КВАДРАНТ



PRIMO ROUND PROF

PRIMO  
ČTVRTKRUH  
/ROUND  
/КВАДРАНТ  
R=55 cm

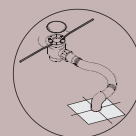
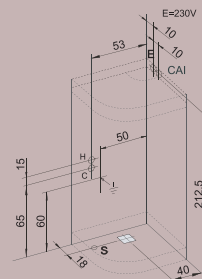
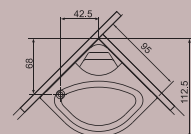
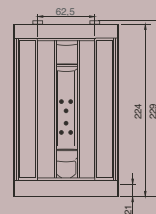

C - přívod studené vody / cold water supply / подвод холодной воды  
H - přívod teplé vody / hot water supply / подвод горячей воды  
E - přívod elektrické energie 230V~ / power wiring 230V~  
/ подвод электричества 230В  
⊥ - zemnicí vodič / ground conductor / заземляющий провод  
CAI - externí anténa - pouze u provedení PROF  
/ external antenna - only PROF version  
/ внешняя антенна - только у исполнения PROF



VERONA TECH 2 PROF

## VERONA TECH 2

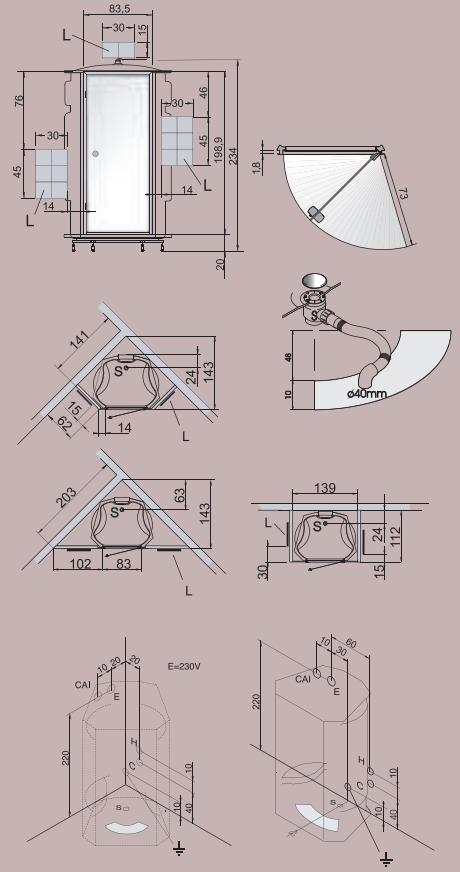

- C - přívod studené vody / cold water supply / подвод холодной воды
- H - přívod teplé vody / hot water supply / подвод горячей воды
- E - přívod elektrické energie 230V~ / power wiring 230V~ / подвод электричества 230В~
- ⊥ - zemní vodič / ground conductor / заземляющий провод
- CAI - externí anténa / external antenna / внешняя антенна
- L - servisní otvory / service opening / сервисные отверстия



PROF

|   | VERONA<br>PROF | MEMPHIS | NEVADA<br>PROF | MAJESTIC<br>PROF | FLEX<br>PROF | PRIMO<br>EASY | PRIMO<br>PROF |
|---|----------------|---------|----------------|------------------|--------------|---------------|---------------|
|  Osvětlení<br>Light<br>Подсветка   | •              | •<br>2X | •<br>2X        | •<br>2X          | •<br>2X      | •             | •             |
|  Turecká parní lázeň<br>Turkish bath<br>Турецкая паровая бан   | •              | •       | •              | •                | •            | •             | •             |
|  Vertikální hydromasážní trysky<br>Vertical hydro massage jets<br>Вертикальные гидромассажные форсунки | •<br>6X        | •<br>6X | •<br>6X        | •<br>6X          | •<br>6X      | •<br>6X       | •<br>6X       |
|  Ruční sprcha<br>Hand shower<br>Ручной душ   | •              | •       | •              | •                | •            | •             | •             |
|  Hlavová sprcha<br>Head shower<br>Головной душ   | •              | •       | •              | •                | •            | •             | •             |
|  Alarm<br>Alarm<br>Сигнал тревоги  | •              | •       | •              | •                | •            | •             | •             |
|  Zádové hydromasážní trysky<br>Back hydro massage jets<br>Бедерные гидромассажные форсунки             | •<br>3X        |         |                |                  |              |               | •<br>3X       |
|  Bederní hydromasážní trysky<br>Loins hydro massage jets<br>Дерék hydro masszázis fúvókák              | •<br>3X        |         |                |                  |              |               | •<br>3X       |
|  Funkce kaskáda<br>Waterfall<br>Функция каскад   | •              |         |                |                  |              |               | •             |
|  Rádio<br>Radio<br>Радио   | •              |         | •              | •                | •            |               | •             |
|  Změna nastavení<br>Change options<br>Изменение настройки   | •              |         | •              | •                | •            |               | •             |
|  LCD displej<br>LCD display<br>LCD дисплей   | •              |         | •              | •                | •            |               | •             |
|  Termostat.baterie Grohe 2000<br>Thermostatic mixer Grohe 2000<br>Термостатический смеситель         | •              | •       | •              | •                | •            | •             | •             |

RIHO kabiny jsou speciálně vyvinuty pro domácí užívání a lze je obdržet v barvách bílá a pergamon.

Pro instalaci parní/sprchovací kabiny RIHO potřebujete: vodovodní přípojku na studenou vodu, odtok s průměrem 40 mm, elektrickou přípojku na 230 V (uzemněnou a se samostatným jištěním), zdroj teplé vody s minimálním tlakem 1 1/2 Bar (doporučujeme 2 a více barů), dodávající min. 8 litrů za minutu s teplotou vody 60°C.

Nevada 100, 120, Majestic 120, 140 a Flex: přívod el. energie 400 V, 2-fázové napětí pro generátor páry 5,8 kW.

Pro sestavení kabiny je zapotřebí pracovní prostor cca 2,5 x plocha kabiny (měřeno od zadní části stěny).

RIHO steam cabins are specially developed for home use and they are available in white and pergamon colours.

To use your RIHO steam/shower cabins, you will need: cold-water distribution pipe, outlet with 40-mm diameter, 230 V electric connection (grounded and with special fuse), sufficient source of heat (combined heater will be the best) with minimum pressure of 1 1/2 bar (we advice 2 bars or more), giving min. 8 litres of 60°C water per minute. The above mentioned requirements are a standard in your housing unit as a rule. Nevada 100, 120, Majestic 120, 140 and Flex: must be el. power 400 V and 2 phase voltage for the steam generator 5.8 kW. The working area of approx. 2.5 x cabin area is needed for cabin assembly (measured from the back wall).

Кабины RIHO разработаны специально для домашнего использования, и изготавливаются в цветах белый и пергамон.

Для подключения Вашей паровой / душевой кабины RIHO необходимо: подключение водопровода с холодной водой, сток с диаметром 40 мм, шина для 230 Вольт (заземленная и со специальным предохранителем), достаточный источник тепла (лучше комбинированный обогреватель) с минимальным давлением 1/2 бар (рекомендуем больше 2 бар), с минимальным расходом 8 литров в минуту 60 °С. Обычно Ваше жилье всем этим обеспечено.

Nevada 100, 120, Majestic 120, 140 и Flex: подвод электрической энергии 400 В, двухфазное напряжение для генераторов пара 5,8 кВт.

Для установки кабины необходимо рабочее пространство прилб. 2,5 x площадь кабины (измерение от задней части стены).





# NÁBYTEK

FURNITURE / МЕБЕЛЬ



# ANDORA





# ANDORA





# ANDORA

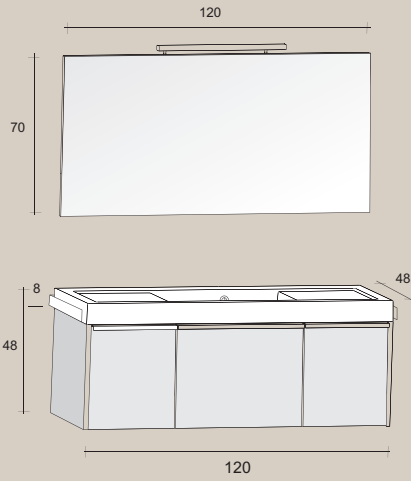

Set 21

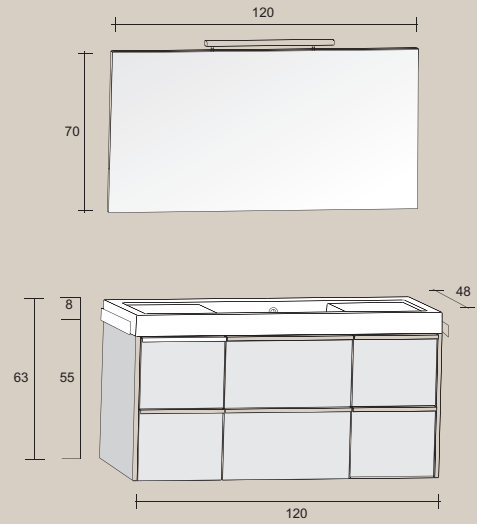

Set 31

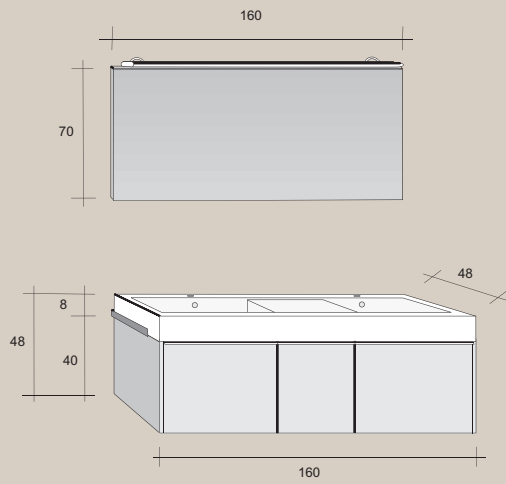

Set 03

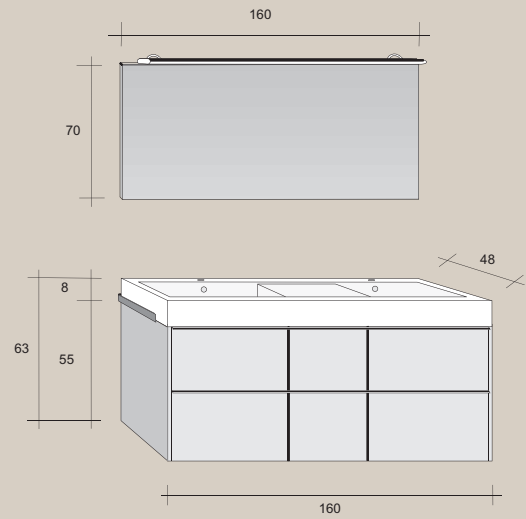

Set 10

Umyvadlo  
Wash basin  
Раковина



Barevné provedení  
Colours  
Расцветка

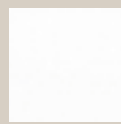

D00

bílá  
white  
белая



D10

bílá-struktura  
white-structure  
белая-структура



DEC

cremona

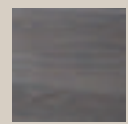

DCA

chateau

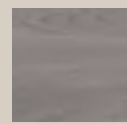

DOR

orne

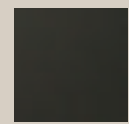



BLK

černá-struktura  
black-structure  
чёрная-структура

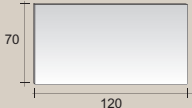
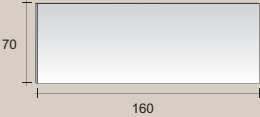
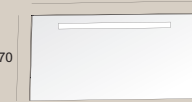
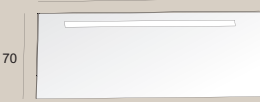
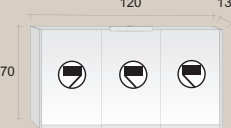
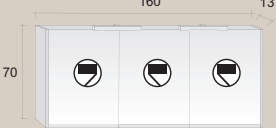
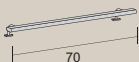
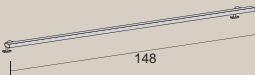
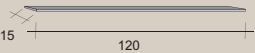
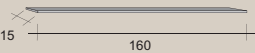
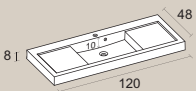
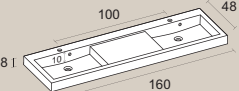
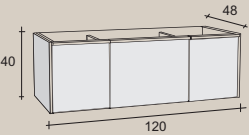
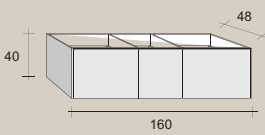
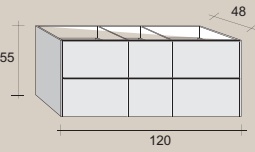
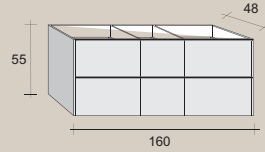
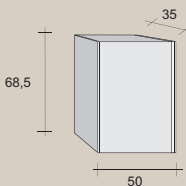
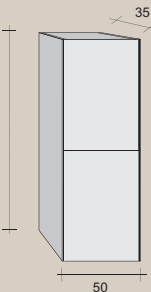
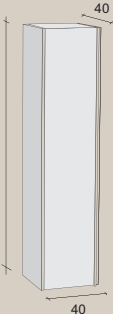
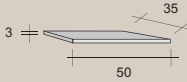
# ANDORA

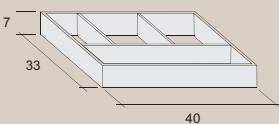
|   |  |   |  |
|---|--|---|--|
| Zrcadlo<br>Mirror<br>Зеркало                                      | 120<br>             | 160<br>                |  |
| Zrcadlo s osvětlením<br>Mirror with lighting<br>Зеркало со светом | 120<br>             | 160<br>                |  |
| Zrcadlová skříňka<br>Mirror cabinet<br>Шкафчик с зеркалом         | 120 13<br>70<br>    | 160 13<br>70<br>       |  |
| Osvětlení<br>Lighting<br>Освещение                                | 70<br>              | 148<br>                |  |
| Police<br>Shelf<br>Полочка  | 15 120<br>         | 15 160<br>            |  |
| Umyvadlo<br>Wash basin<br>Раковина                                | 81 48<br>120<br>  | 81 48<br>100 160<br> |  |
| Umyvadlová skříňka<br>Wash basin cabinet<br>Шкафчик под раковину  | 40 48<br>120<br>  | 40 48<br>160<br>     |  |
| Umyvadlová skříňka<br>Wash basin cabinet<br>Шкафчик под раковину  | 55 48<br>120<br>  | 55 48<br>160<br>     |  |
| Skříňka<br>Cabinet<br>Шкафчик                                     | 68,5 35<br>50<br> | 137,4 35<br>50<br>   | 171,5 40<br>40<br> |
| Krycí deska<br>Cover board<br>Декоративная доска                  | 3 35<br>50<br>    |   |  |

|   |   |  |
|---|---|--|
| <p>Držák<br/>Towel holder<br/>Держатель для полотенца</p>                           |  |  |
| <p>Organizér zásuvky<br/>Drawer organizer<br/>Разделение для выдвижного шкафика</p> |  |  |
| <p>Výpusť (Clac-Clac)<br/>Clac Clac<br/>Водослив для умывальника</p>                |  |  |

# BOLOGNA





# BOLOGNA





# BOLOGNA

Umyvadlo  
Wash basin  
Раковина

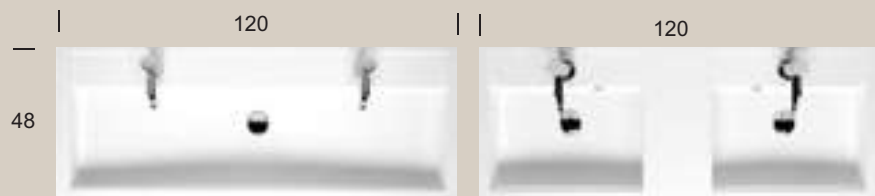
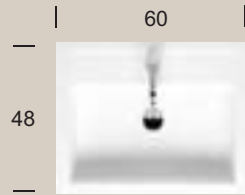

Barevné provedení  
Colours  
Расцветка

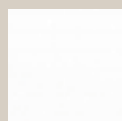

D00

bílá  
white  
белая



D10

bílá-struktura  
white-structure  
белая-структура

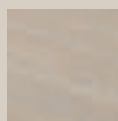

DEC

cremona

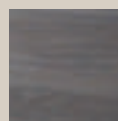

DCA

chateau



DOR

orme

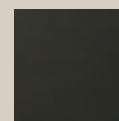

BLK

černá-struktura  
black-structure  
чёрная-структура



R01

bílá-lesk  
white-shiny  
белая-лоск

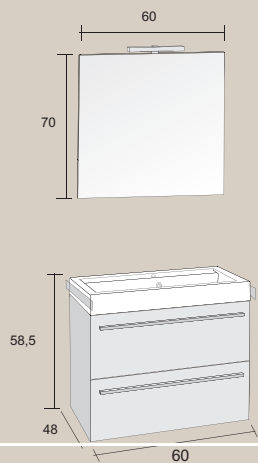

Set 33

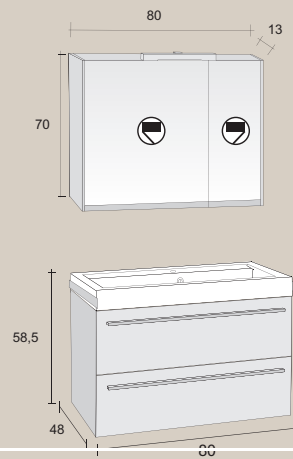

Set 38

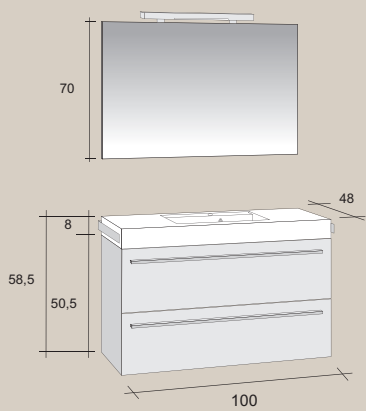

Set 31

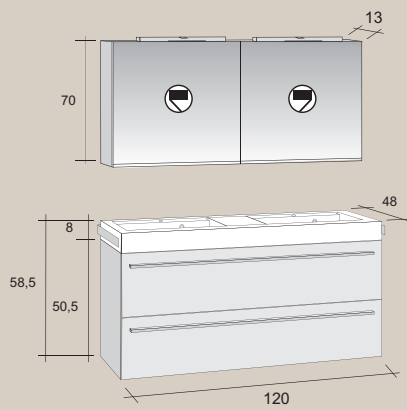

Set 25

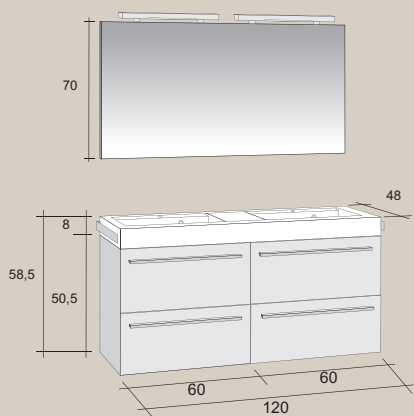



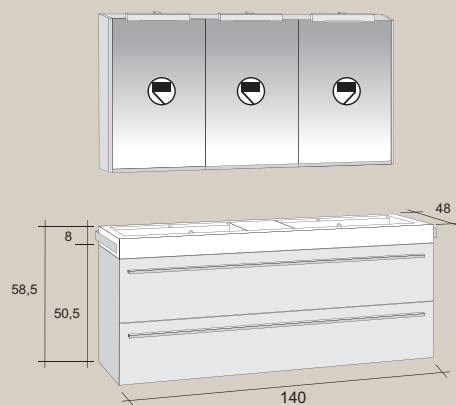





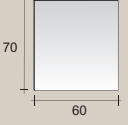
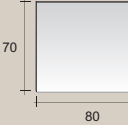
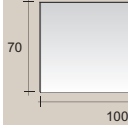
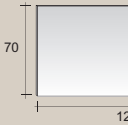
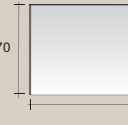
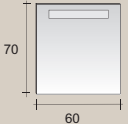
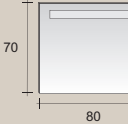
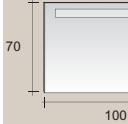
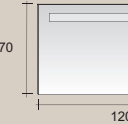
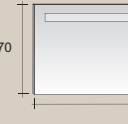
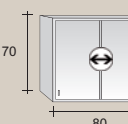
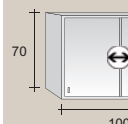
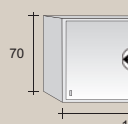
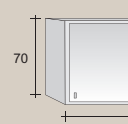
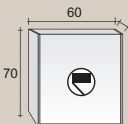
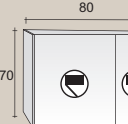
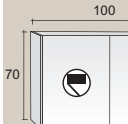
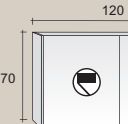

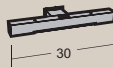
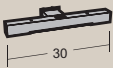
Set 35

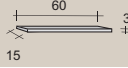
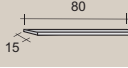
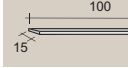
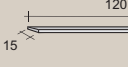
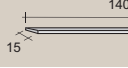
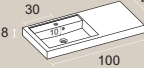

Set 27

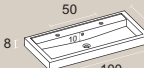
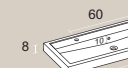
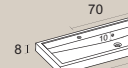
# BOLOGNA

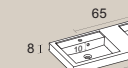
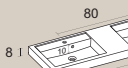
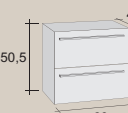
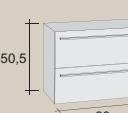
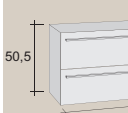
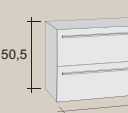
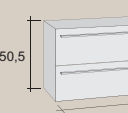
|   |   |   |  |  |  |
|---|---|---|--|--|--|
| Zrcadlo<br>Mirror<br>Зеркало                                      | 60<br>                 | 80<br>                 | 100<br>                 | 120<br>                 | 140<br>                 |
| Zrcadlo s osvětlením<br>Mirror with lighting<br>Зеркало со светом | 60<br>                 | 80<br>                 | 100<br>                 | 120<br>                 | 140<br>                 |
| Zrcadlová skříňka<br>Mirror cabinet<br>Шкафчик с зеркалом         |   | 80<br>                 | 100<br>                 | 120<br>                 | 140<br>                 |
| Zrcadlová skříňka<br>Mirror cabinet<br>Шкафчик с зеркалом         | 60<br>                 | 80<br>                 | 100<br>                 | 120<br>                 | 140<br>                 |
| Osvětlení<br>Lighting<br>Освещение                                |   |                       |  |                       |                        |
| Police<br>Shelf<br>Полочка  | 60<br>               | 80<br>               | 100<br>               | 120<br>               | 140<br>               |
| Umyvadlo<br>Wash basin<br>Раковина                                |   |   | 30<br>48<br>100<br>   |  |  |
|   |   |   | 30<br>48<br>100<br>   |  |  |
|   | 8<br>48<br>60<br>    | 8<br>48<br>80<br>    | 8<br>48<br>100<br>    |  |  |
|   |   |   | 8<br>48<br>100<br>    | 8<br>48<br>120<br>    | 8<br>48<br>140<br>    |
|   |   | 8<br>48<br>80<br>    | 8<br>48<br>100<br>    | 8<br>48<br>120<br>    | 8<br>48<br>140<br>    |
| Umyvadlová skříňka<br>Wash basin cabinet<br>Шкафчик под раковину  | 50,5<br>60<br>48<br> | 50,5<br>80<br>48<br> | 50,5<br>100<br>48<br> | 50,5<br>120<br>48<br> | 50,5<br>140<br>48<br> |

Skříňka  
Cabinet  
Шкафчик

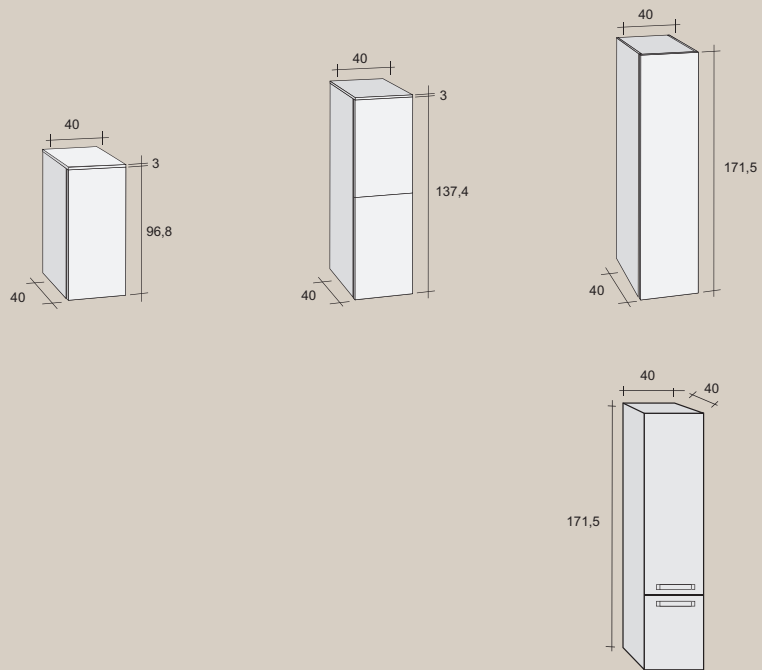

Krycí deska  
Cover board  
Разделение для выдвижного шкафчика

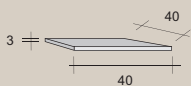

Držák  
Towel holder  
Держатель для полотенца



Sifon chromový  
Chrome siphon  
Разделение для выдвижного шкафчика



Organizér zásuvky  
Drawer organizer  
Разделение для выдвижного шкафчика

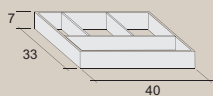

Výpust (Clic-Clac)  
Clic Clac  
Водослив для умывальника



# BRONI



Umyvadlo  
Wash basin  
Раковина

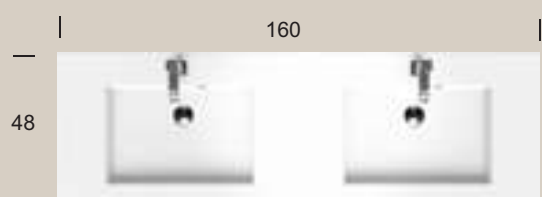
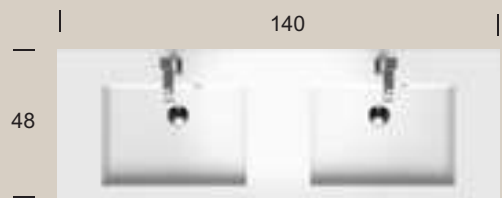
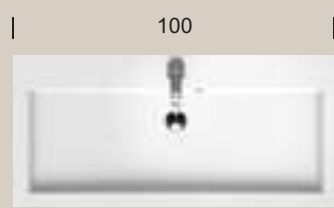
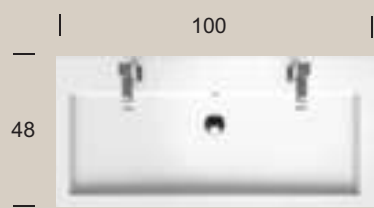
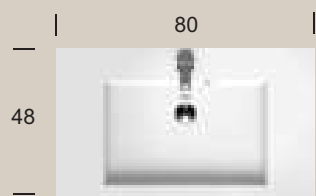

Barevné provedení  
Colours  
Расцветка



D00

bílá  
white  
белая

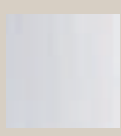

D10

bílá-struktura  
white-structure  
белая-структура

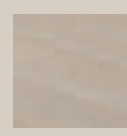

DEC

cremona

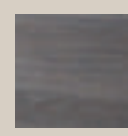

DCA

chateau



DOR

orme

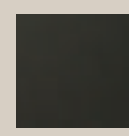

BLK

černá-struktura  
black-structure  
чёрная-структура

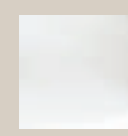

R01

bílá-lesk  
white-shiny  
белая-лоск

# BRONI

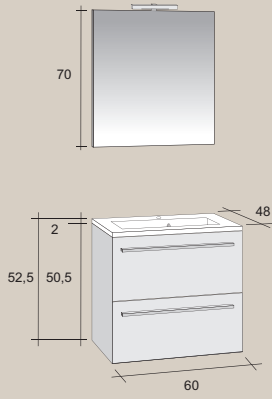

Set 33

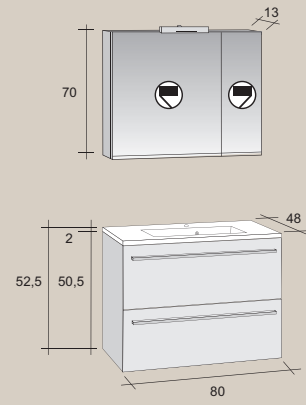

Set 38

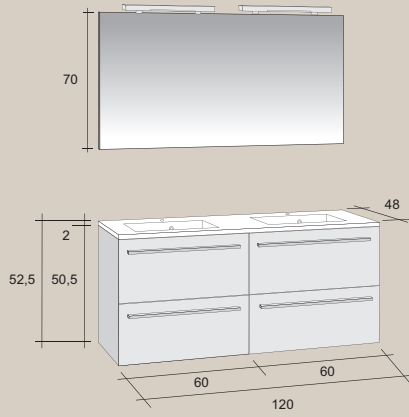

Set 35

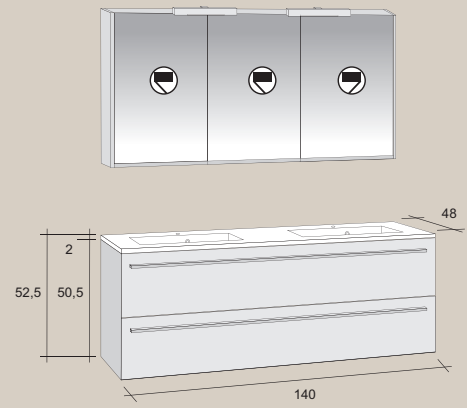

Set 27

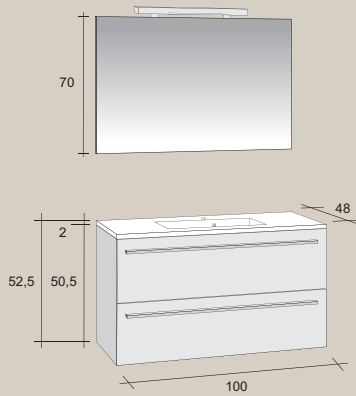



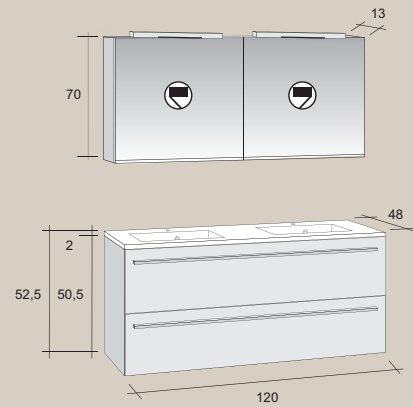







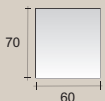

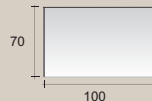

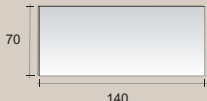
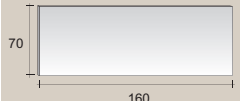
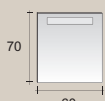

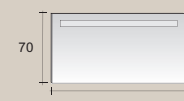
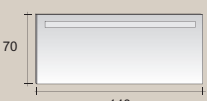
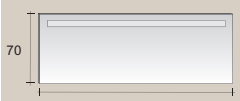
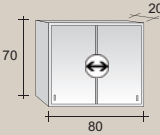
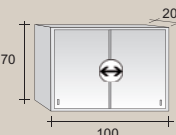
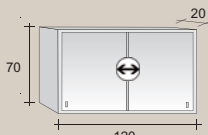
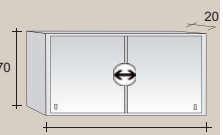
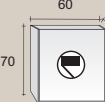
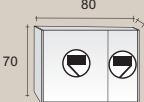
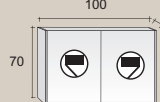
Set 31





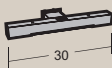
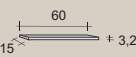
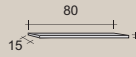
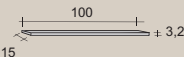
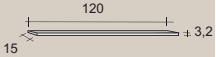

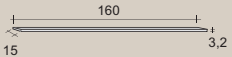
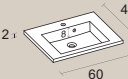
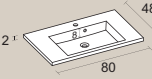
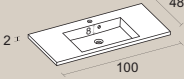
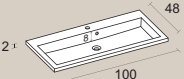
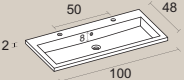
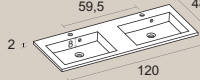
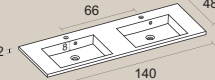
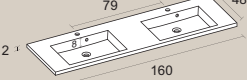
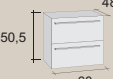
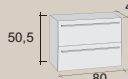
Set 25

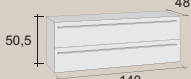
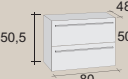
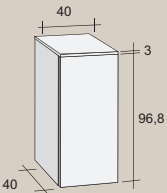
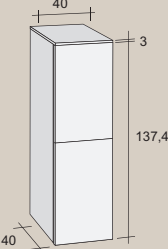
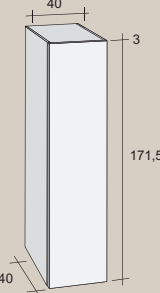

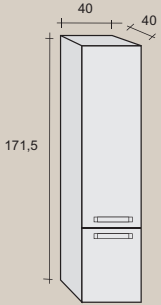
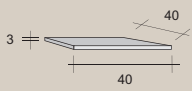
# BRONI

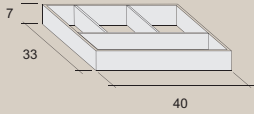
|   |  |   |  |   |  |  |
|---|--|---|--|---|--|--|
| Zrcadlo<br>Mirror<br>Зеркало                                      | 60<br>  | 80<br>   | 100<br>   | 120<br>    | 140<br>   | 160<br>   |
| Zrcadlo s osvětlením<br>Mirror with lighting<br>Зеркало со светом | 60<br>  | 80<br>   | 100<br>   | 120<br>    | 140<br>   | 160<br>   |
| Zrcadlová skříňka<br>Mirror cabinet<br>Шкафчик с зеркалом         |  | 80<br>   | 100<br>   | 120<br>   | 140<br>   |  |
| Zrcadlová skříňka<br>Mirror cabinet<br>Шкафчик с зеркалом         | 60<br>  | 80<br>   | 100<br>   | 120<br>    | 140<br>   | 160<br>   |
| Osvětlení<br>Lighting<br>Освещение                                |  |         |  |         |  |          |
| Police<br>Shelf<br>Полочка  | 60<br>  | 80<br> | 100<br> | 120<br> | 140<br> | 160<br> |
| Umyvadlo<br>Wash basin<br>Раковина                                | 60<br>  | 80<br> | 100<br> |   |  |  |
|   |  |   | 100<br> |   |  |  |
|   |  |   | 100<br> | 120<br> | 140<br> | 160<br> |
| Umyvadlová skříňka<br>Wash basin cabinet<br>Шкафчик под раковину  | 60<br>  | 80<br> | 100<br> | 120<br> | 140<br> | 80<br>  |
| Skříňka<br>cabinet<br>Шкафчик                                     |    |   |  |   |  |  |

|  |   |  |
|--|---|--|
| <p>Skříňka<br/>Cabinet<br/>Шкафчик</p>   |    |  |
| <p>Krycí deska<br/>Covering board<br/>Декоративная доска</p>                         |    |  |
| <p>Sifon chromový<br/>Chrome siphon<br/>Разделение для выдвижного шкафчика</p>       |    |  |
| <p>Organizér zásuvky<br/>Drawer organizer<br/>Разделение для выдвижного шкафчика</p> |   |  |
| <p>Výpust (Clic-Clac)<br/>Clic Clac<br/>Водослив для умывальника</p>                 |  |  |

# EIFEL



Umyvadlo  
Wash basin  
Раковина

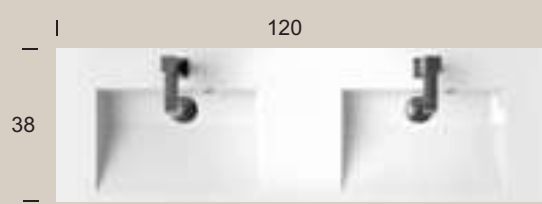
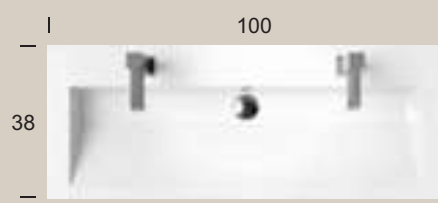
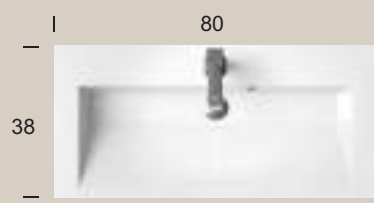
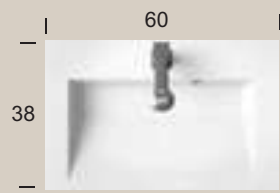

Barevné provedení  
Colours  
Расцветка

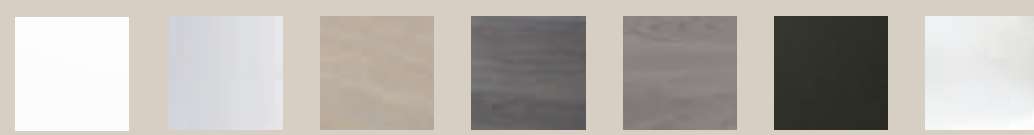

|                        |  |         |         |      |  |  |
|------------------------|--|---------|---------|------|--|--|
| D00                    | D10  | DEC     | DCA     | DOR  | BLK  | R01                                    |
| bílá<br>white<br>белая | bílá–struktura<br>white–structure<br>белая–структура | cremona | chateau | orne | černá–struktura<br>black–structure<br>чёрная–структура | bílá–lesk<br>white–shiny<br>белая–лоск |

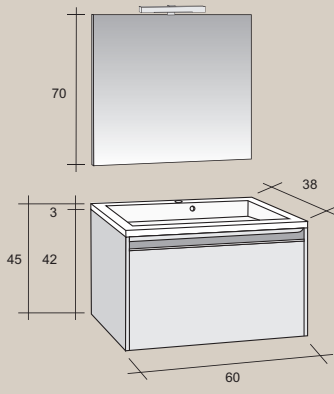

Set 01

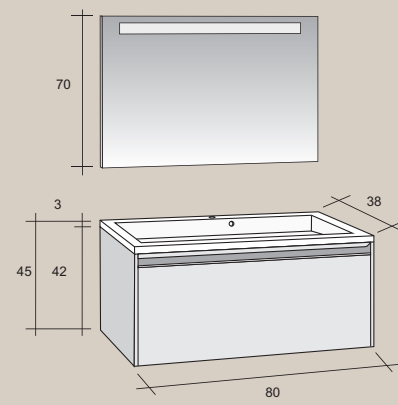

Set 05

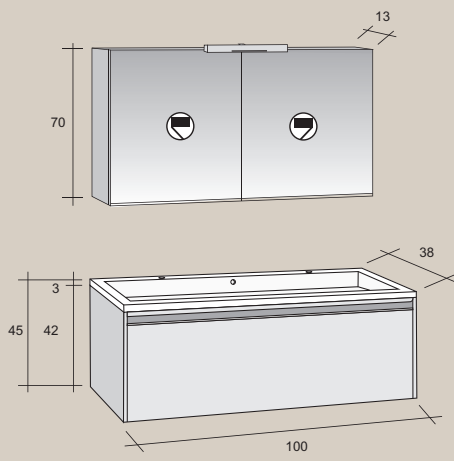



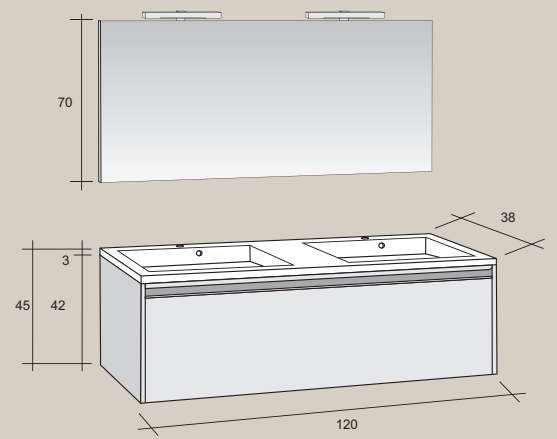

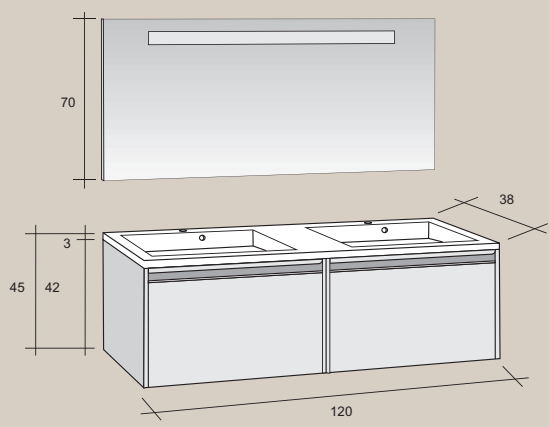

Set 09

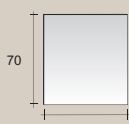
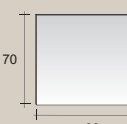
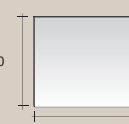

Set 10

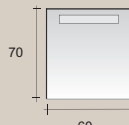
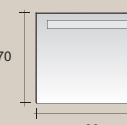
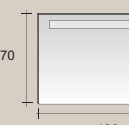
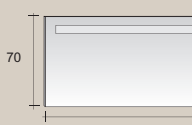
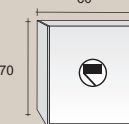
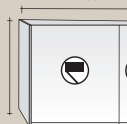
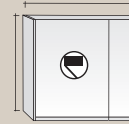
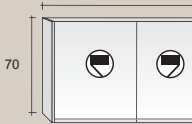
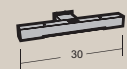

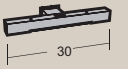
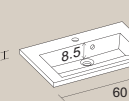
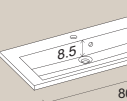
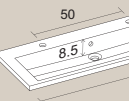
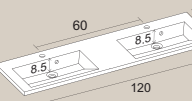
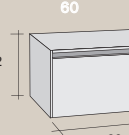
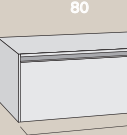
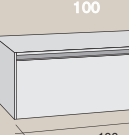
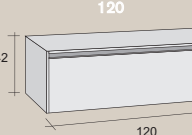
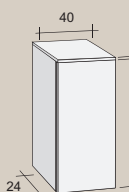
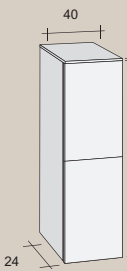
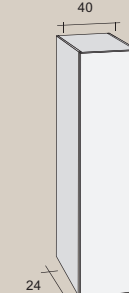
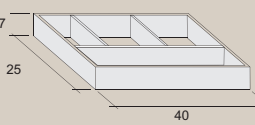
Set 14

|   |  |  |   |  |
|---|--|--|---|--|
| <p>Zrcadlo<br/>Mirror<br/>Зеркало</p>   | <p>60<br/>70<br/>60</p>       | <p>80<br/>70<br/>80</p>       | <p>100<br/>70<br/>100</p>         | <p>120<br/>70<br/>120</p>   |
| <p>Zrcadlo s osvětlením<br/>Mirror with lighting<br/>Зеркало со светом</p>            | <p>70<br/>60</p>              | <p>70<br/>80</p>              | <p>70<br/>100</p>                 | <p>70<br/>120</p>   |
| <p>Zrcadlová skříňka<br/>Mirror cabinet<br/>Шкафчик с зеркалом</p>                    | <p>60 13<br/>70</p>           | <p>80 13<br/>70</p>           | <p>100 13<br/>70</p>              | <p>120 13<br/>70</p>    |
| <p>Osvětlení<br/>Lighting<br/>Освещение</p>   |  <p>30</p>                    |  |   |   <p>30 30</p> |
| <p>Umyvadlo<br/>Wash basin<br/>Раковина</p>   | <p>3 I 38<br/>8.5<br/>60</p>  | <p>3 I 38<br/>8.5<br/>80</p>  | <p>3 I 38<br/>50 8.5<br/>100</p>  | <p>3 I 38<br/>60 8.5<br/>120</p>    |
| <p>Umyvadlová skříňka<br/>Wash basin cabinet<br/>Шкафчик под раковину</p>             | <p>60 38<br/>42<br/>60</p>   | <p>80 38<br/>42<br/>80</p>   | <p>100 38<br/>42<br/>100</p>     | <p>120 38<br/>42<br/>120</p>   |
| <p>Skříňka<br/>Cabinet<br/>Шкафчик</p>  | <p>40 1.8<br/>24 96.8</p>   | <p>40 1.8<br/>24 137.4</p>  | <p>40 171.5<br/>24</p>          |  |
| <p>Organizer zástavky<br/>Drawer organizer<br/>Разделение для выдвижного шкафчика</p> | <p>7 25 40</p>              |  |   |  |
| <p>Výpusť (Clic-Clac)<br/>Clic Clac<br/>Водослив для умывальника</p>                  |                             |  |   |  |





# ELZAS



Umyvadlo  
Wash basin  
Раковина

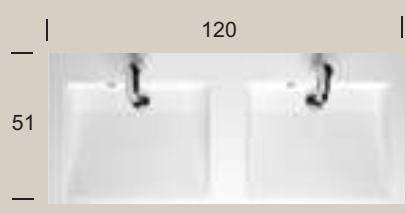
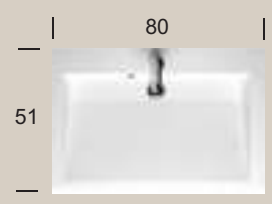

Barevné provedení  
Colours  
Расцветка

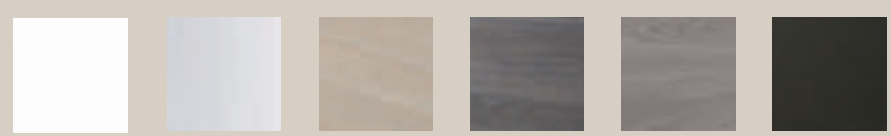

|                        |  |         |         |      |  |
|------------------------|--|---------|---------|------|--|
| D00                    | D10  | DEC     | DCA     | DOR  | BLK  |
| bílá<br>white<br>белая | bílá–struktura<br>white–structure<br>белая–структура | cremona | chateau | orme | černá–struktura<br>black–structure<br>чёрная–структура |

# ELZAS

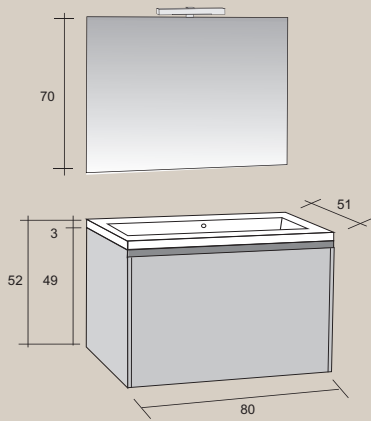



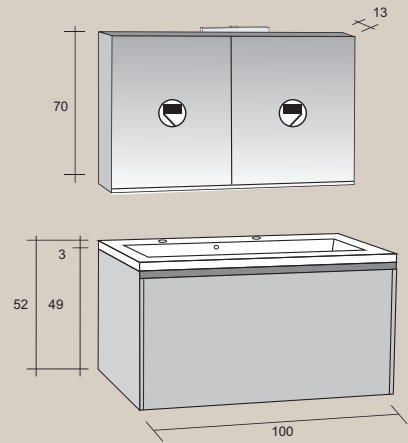

Set 01

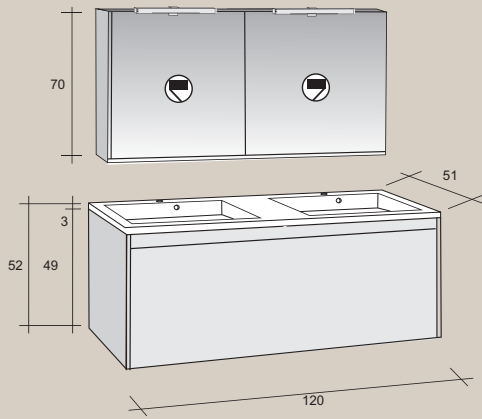

Set 06

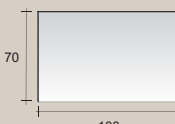
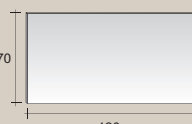
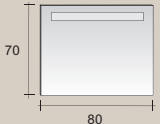
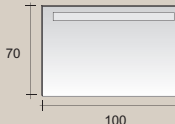
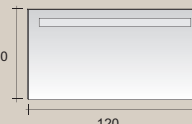
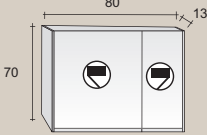
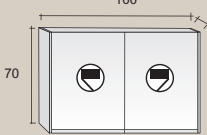
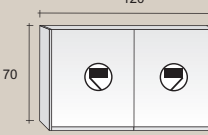

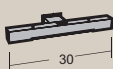
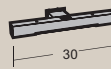
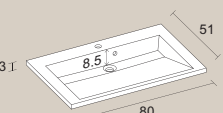
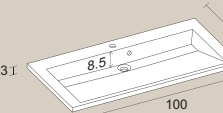
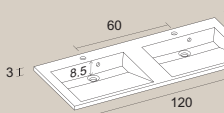
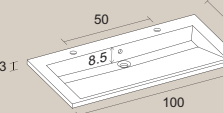
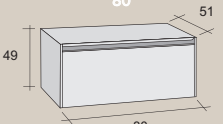
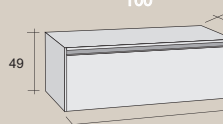
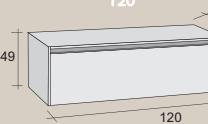
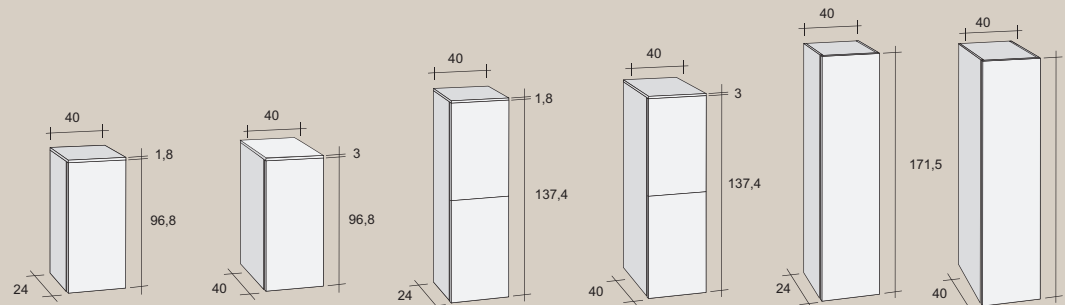
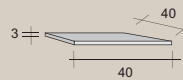
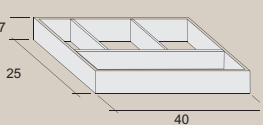
Set 09

|   |  |  |   |  |
|---|--|--|---|--|
| <p>Zrcadlo<br/>Mirror<br/>Zrcadlo</p>   | <p>80<br/></p>                        | <p>100<br/></p>                         | <p>120<br/></p>   |  |
| <p>Zrcadlo s osvětlením<br/>Mirror with lighting<br/>Зеркало со светом</p>            | <p>80<br/></p>                        | <p>100<br/></p>                         | <p>120<br/></p>   |  |
| <p>Zrcadlová skříňka<br/>Mirror cabinet<br/>Шкафчик с зеркалом</p>                    | <p>80<br/>13<br/>70<br/></p>          | <p>100<br/>13<br/>70<br/></p>           | <p>120<br/>13<br/>70<br/></p>   |  |
| <p>Osvětlení<br/>Lighting<br/>Освещение</p>   | <p></p>                               |  | <p> </p> |  |
| <p>Umyvadlo<br/>Wash basin<br/>Раковина</p>   | <p>80<br/>51<br/>8.5<br/>3 I<br/></p> | <p>100<br/>51<br/>8.5<br/>3 I<br/></p>  | <p>120<br/>51<br/>8.5<br/>3 I<br/></p>  |  |
|   |  | <p>50<br/>51<br/>8.5<br/>3 I<br/></p> |   |  |
| <p>Umyvadlová skříňka<br/>Wash basin cabinet<br/>Шкафчик под раковину</p>             | <p>80<br/>51<br/>49<br/>80<br/></p> | <p>100<br/>51<br/>49<br/>100<br/></p> | <p>120<br/>51<br/>49<br/>120<br/></p>   |  |
| <p>Skříňka<br/>Cabinet<br/>Шкафчик</p>  | <p></p>                            |  |   |  |
| <p>Krycí deska<br/>Covering board<br/>Декоративная доска</p>                          | <p></p>                             |  |   |  |
| <p>Organizer zástavky<br/>Drawer organizer<br/>Разделение для выдвижного шкафчика</p> | <p></p>                             |  |   |  |
| <p>Výpusť (Clic-Clac)<br/>Clic Clac<br/>Водослив для умывальника</p>                  | <p></p>                             |  |   |  |



Umyvadlo  
Wash basin  
Раковина

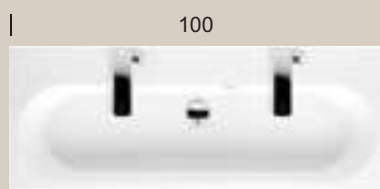
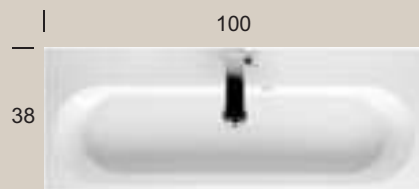
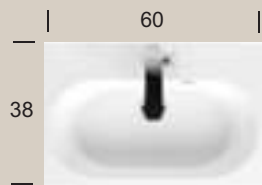

Barevné provedení  
Colours  
Расцветка



D00

bílá  
white  
белая

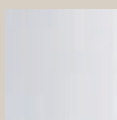

D10

bílá-struktura  
white-structure  
белая-структура

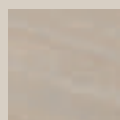

DEC

cremona

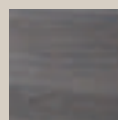

DCA

chateau

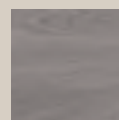

DOR

orme

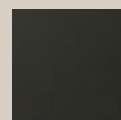

BLK

černá-struktura  
black-structure  
чёрная-структура



R01

bílá-lesk  
white-shiny  
белая-поск

# ESTÉE

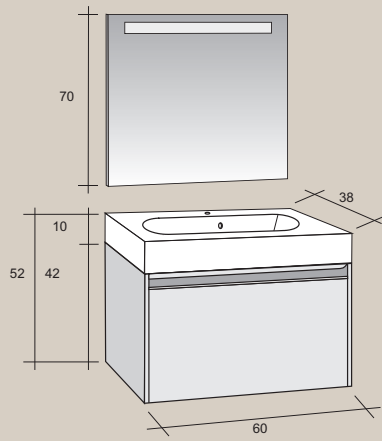

Set 01

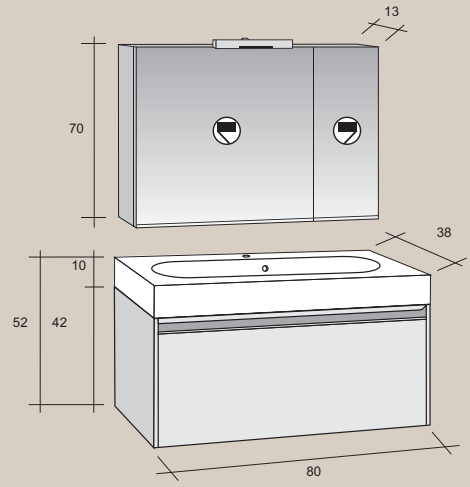



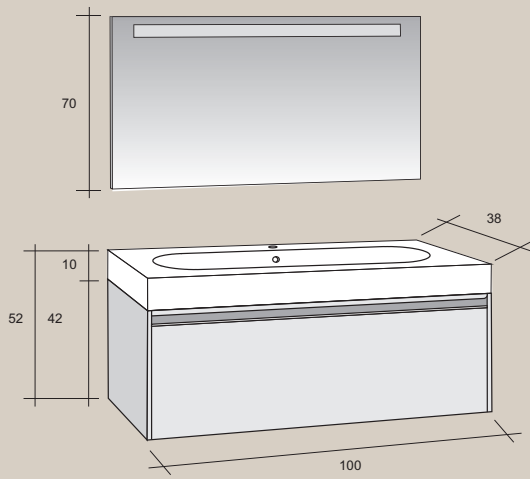



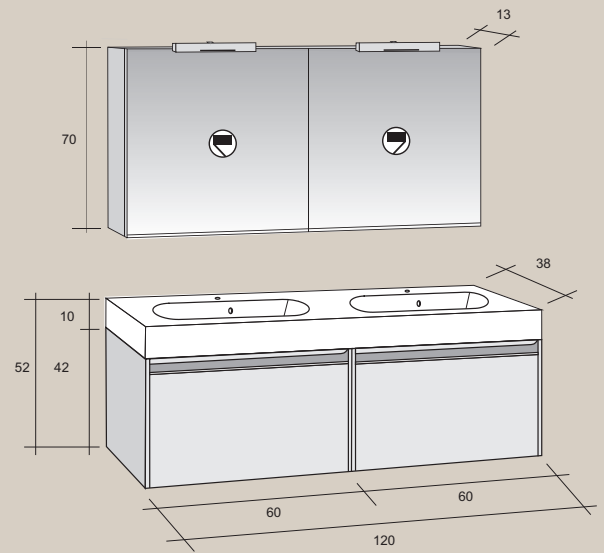

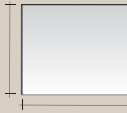
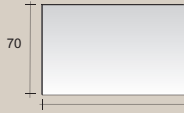
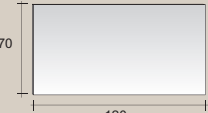
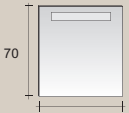
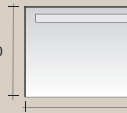
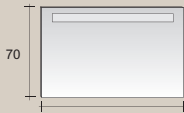
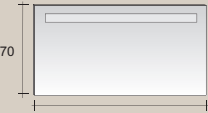
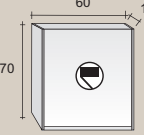
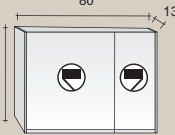
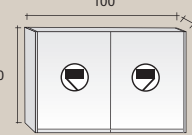
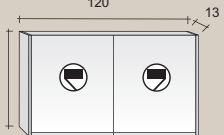
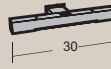

Set 06

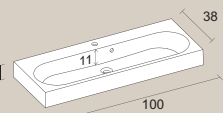
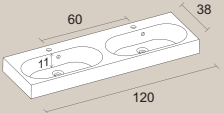

Set 10

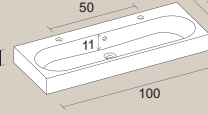

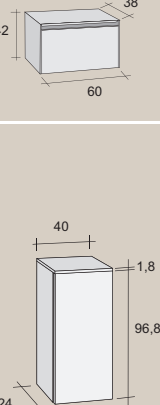
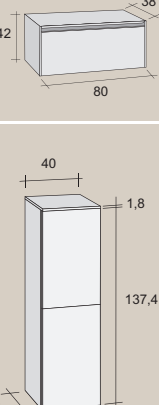
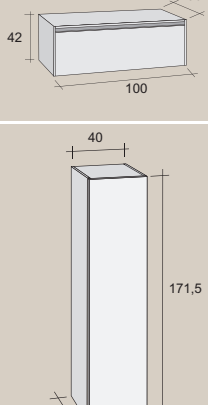
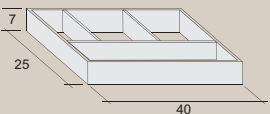
Set 21

|   |   |  |  |  |
|---|---|--|--|--|
| <p>Zrcadlo<br/>Mirror<br/>Зеркало</p>   | <p>60<br/>70<br/>60</p>      | <p>80<br/>70<br/>80</p>       | <p>100<br/>70<br/>100</p>  | <p>120<br/>70<br/>120</p>   |
| <p>Zrcadlo s osvětlením<br/>Mirror with lighting<br/>Зеркало со светом</p>              | <p>60<br/>70<br/>60</p>      | <p>80<br/>70<br/>80</p>       | <p>100<br/>70<br/>100</p>  | <p>120<br/>70<br/>120</p>   |
| <p>Zrcadlová skříňka<br/>Mirror cabinet<br/>Шкафчик с зеркалом</p>                      | <p>60 13<br/>70</p>          | <p>80 13<br/>70</p>           | <p>100 13<br/>70</p>       | <p>120 13<br/>70</p>    |
| <p>Osvětlení<br/>Lighting<br/>Освещение</p>   |  <p>30</p>                   |  |  |   <p>30 30</p> |
| <p>Umyvadlo<br/>Wash basin<br/>Раковина</p>   | <p>10 38<br/>60</p>          | <p>10 38<br/>80</p>           | <p>10 38<br/>100</p>       | <p>10 38<br/>60 120</p>   |
| <p>Umyvadlová skříňka<br/>Wash basin cabinet<br/>Шкафчик под раковину</p>               | <p>42 38<br/>60</p>        | <p>42 38<br/>80</p>         | <p>42 38<br/>100</p>     | <p>42 38<br/>60 60</p>    |
| <p>Skříňka<br/>Cabinet<br/>Шкафчик</p>  | <p>40 1,8 96,8<br/>24</p>  | <p>40 1,8 137,4<br/>24</p>  | <p>40 171,5<br/>24</p>   |  |
| <p>Organizer zástavky<br/>Drawer organizer<br/>Разделение для выдвигающего шкафчика</p> | <p>7 25 40</p>             |  |  |  |
| <p>Výpusť (Clic-Clac)<br/>Clic Clac<br/>Водослив для умывальника</p>                    |                            |  |  |  |

# EVRY



Umyvadlo  
Wash basin  
Раковина

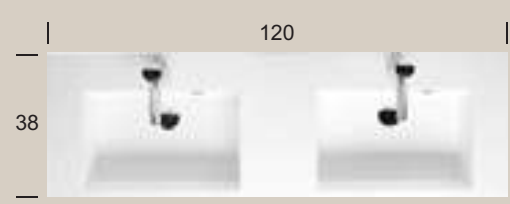
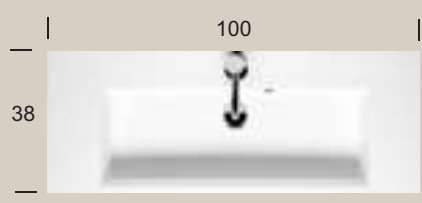
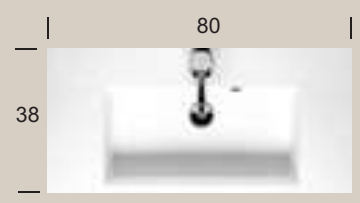

Barevné provedení  
Colours  
Расцветка



D00

bílá  
white  
белая

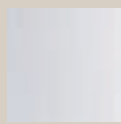

D10

bílá-struktura  
white-structure  
белая-структура

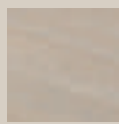

DEC

cremona

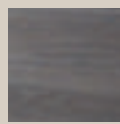

DCA

chateau



DOR

orme

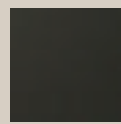

BLK

černá-struktura  
black-structure  
чёрная-структура



R01

bílá-lesk  
white-shiny  
белая-лоск

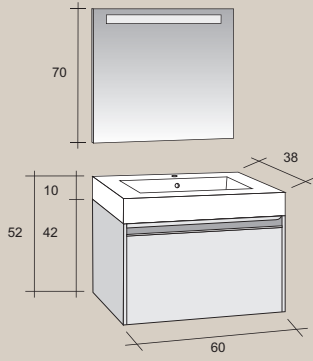

Set 01

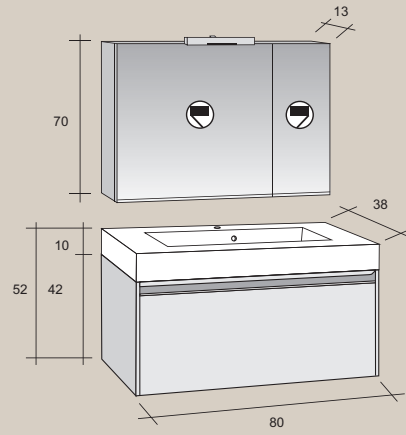



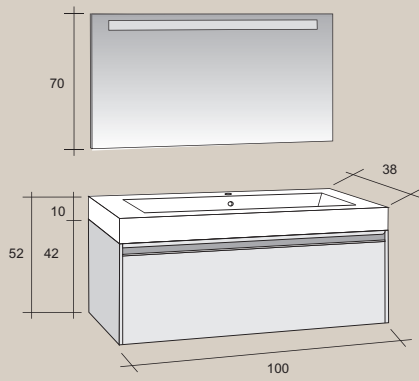

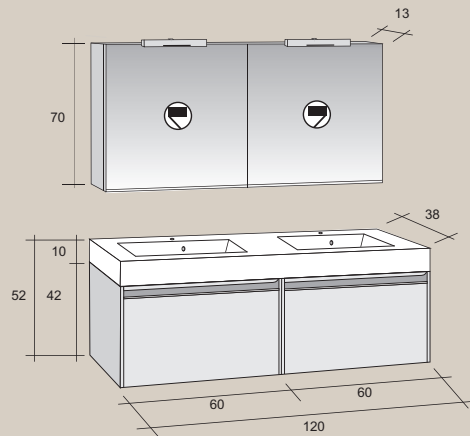

Set 06

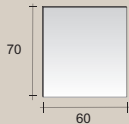
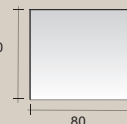
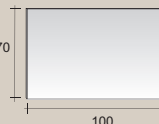
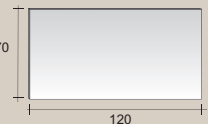
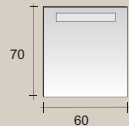
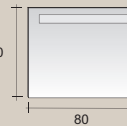
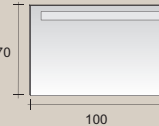
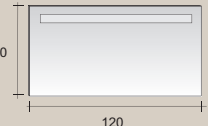
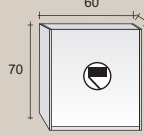
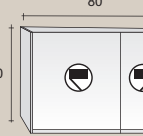
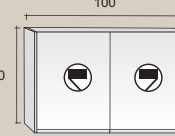
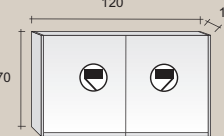

Set 10

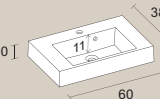
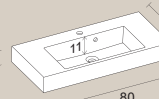
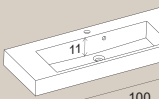
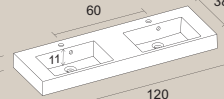
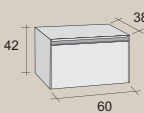
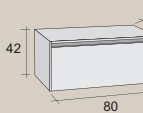
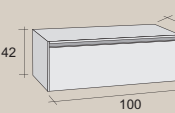
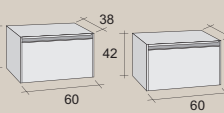
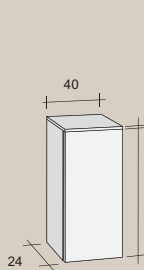
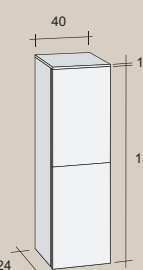
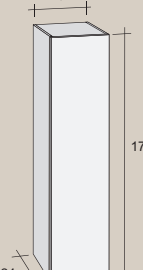
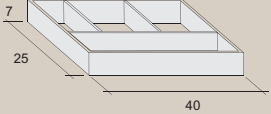

Set 21



|   |   |  |  |  |
|---|---|--|--|--|
| <p>Zrcadlo<br/>Mirror<br/>Zrcadlo</p>   | <p>60<br/></p>                   | <p>80<br/></p>                    | <p>100<br/></p>                  | <p>120<br/></p>   |
| <p>Zrcadlo s osvětlením<br/>Mirror with lighting<br/>Зеркало со светом</p>            | <p>60<br/></p>                   | <p>80<br/></p>                    | <p>100<br/></p>                  | <p>120<br/></p>   |
| <p>Zrcadlová skříňka<br/>Mirror cabinet<br/>Шкафчик с зеркалом</p>                    | <p>60 13<br/>70<br/></p>         | <p>80 13<br/>70<br/></p>          | <p>100 13<br/>70<br/></p>        | <p>120 13<br/>70<br/></p>   |
| <p>Osvětlení<br/>Lighting<br/>Освещение</p>   | <p></p>                          |  |  | <p> </p> |
| <p>Umyvadlo<br/>Wash basin<br/>Раковина</p>   | <p>60 38<br/>10<br/>11<br/></p>  | <p>80 38<br/>10<br/>11<br/></p>   | <p>100 38<br/>10<br/>11<br/></p> | <p>120 38<br/>10<br/>11<br/></p>  |
| <p>Umyvadlová skříňka<br/>Wash basin cabinet<br/>Шкафчик под раковину</p>             | <p>60 38<br/>42<br/></p>       | <p>80 38<br/>42<br/></p>        | <p>100 38<br/>42<br/></p>      | <p>120 38<br/>42<br/></p>   |
| <p>Skříňka<br/>Cabinet<br/>Шкафчик</p>  | <p>40 1.8<br/>24 96.8<br/></p> | <p>40 1.8<br/>24 137.4<br/></p> | <p>40 171.5<br/>24<br/></p>   |  |
| <p>Organizer zástuvky<br/>Drawer organizer<br/>Разделение для выдвижного шкафчика</p> | <p>7 25 40<br/></p>            |  |  |  |
| <p>Výpust (Clic-Clac)<br/>Clic Clac<br/>Водослив для умывальника</p>                  | <p></p>                        |  |  |  |

# LIGNA



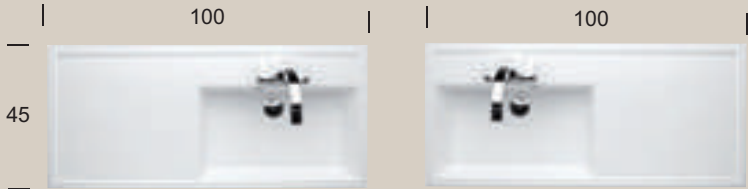

# LIGNA

|  |  |         |         |      |  |  |  |     |     |     |     |     |     |                        |  |         |         |      |  |
|--|--|---------|---------|------|--|--|--|-----|-----|-----|-----|-----|-----|------------------------|--|---------|---------|------|--|
| <p>Umyvadlo<br/>Wash basin<br/>Раковина</p>        |    |         |         |      |  |  |  |     |     |     |     |     |     |                        |  |         |         |      |  |
|  |    |         |         |      |  |  |  |     |     |     |     |     |     |                        |  |         |         |      |  |
| <p>Barevné provedení<br/>Colours<br/>Расцветка</p> | <table border="0"> <tr> <td data-bbox="555 788 673 904"></td> <td data-bbox="711 788 829 904"></td> <td data-bbox="868 788 986 904"></td> <td data-bbox="1024 788 1142 904"></td> <td data-bbox="1165 788 1283 904"></td> <td data-bbox="1321 788 1439 904"></td> </tr> <tr> <td data-bbox="555 922 603 949">D00</td> <td data-bbox="711 922 759 949">D10</td> <td data-bbox="868 922 916 949">DEC</td> <td data-bbox="1024 922 1072 949">DCA</td> <td data-bbox="1165 922 1212 949">DOR</td> <td data-bbox="1321 922 1369 949">BLK</td> </tr> <tr> <td data-bbox="555 990 603 1048">bílá<br/>white<br/>белая</td> <td data-bbox="711 990 823 1048">bílá-struktura<br/>white-structure<br/>белая-структура</td> <td data-bbox="868 990 932 1008">cremona</td> <td data-bbox="1024 990 1072 1008">chateau</td> <td data-bbox="1165 990 1209 1008">orme</td> <td data-bbox="1321 990 1439 1048">černá-struktura<br/>black-structure<br/>чёрная-структура</td> </tr> </table> |         |         |      |  |  |  | D00 | D10 | DEC | DCA | DOR | BLK | bílá<br>white<br>белая | bílá-struktura<br>white-structure<br>белая-структура | cremona | chateau | orme | černá-struktura<br>black-structure<br>чёрная-структура |
|  |  |         |         |      |  |  |  |     |     |     |     |     |     |                        |  |         |         |      |  |
| D00  | D10  | DEC     | DCA     | DOR  | BLK  |  |  |     |     |     |     |     |     |                        |  |         |         |      |  |
| bílá<br>white<br>белая                             | bílá-struktura<br>white-structure<br>белая-структура   | cremona | chateau | orme | černá-struktura<br>black-structure<br>чёрная-структура |  |  |     |     |     |     |     |     |                        |  |         |         |      |  |

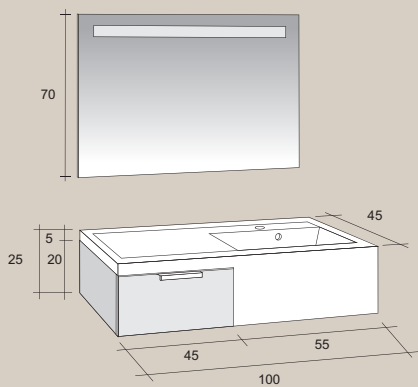

Set 15

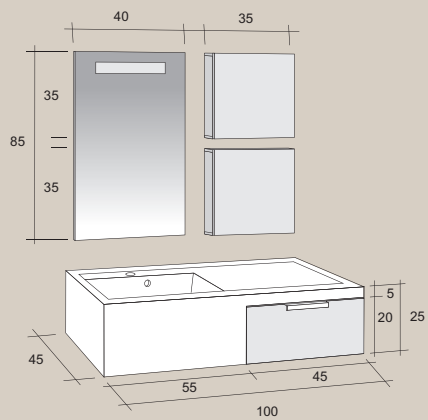

Set 12

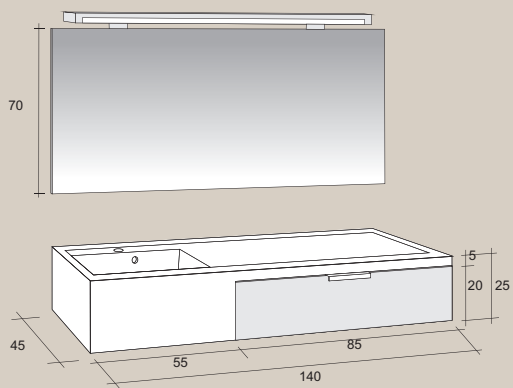



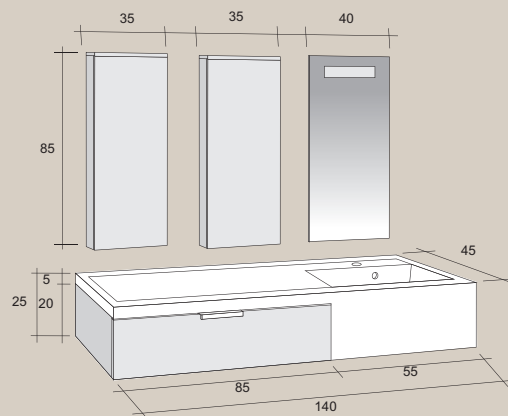

Set 21

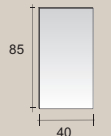
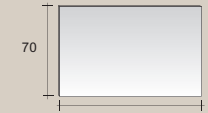
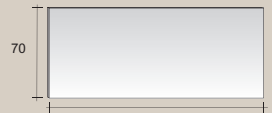
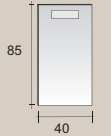
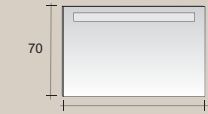
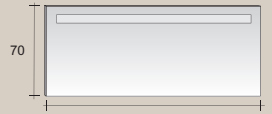

Set 24

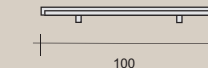
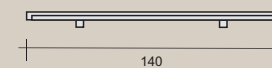
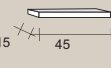
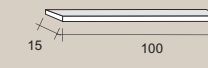
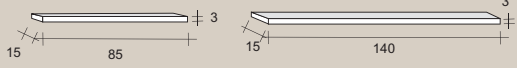
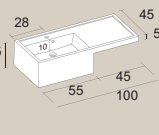
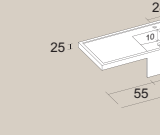
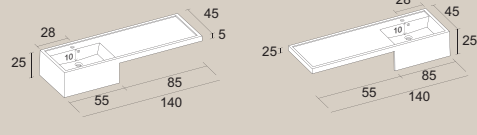
# LIGNA

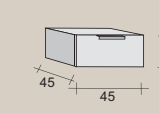
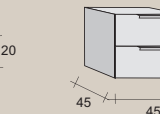
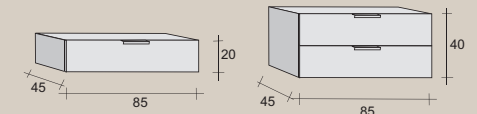
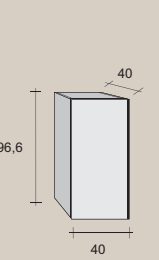
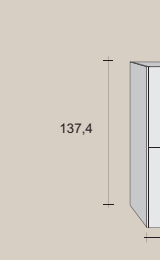
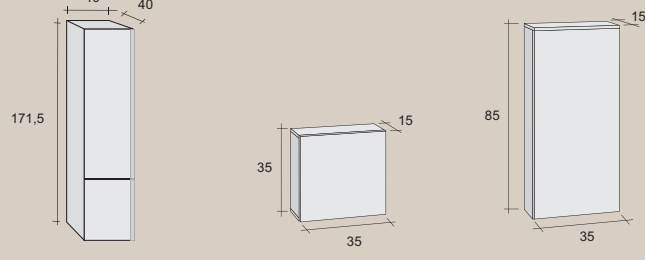
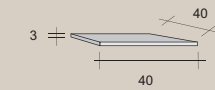
|  |   |   |   |
|--|---|---|---|
| <p>Zrcadlo<br/>Mirror<br/>Зеркало</p>                                      | <p>40<br/>85<br/>40</p>      | <p>100<br/>70<br/>100</p>    | <p>140<br/>70<br/>140</p>                       |
| <p>Zrcadlo s osvětlením<br/>Mirror with lighting<br/>Зеркало со светом</p> | <p>85<br/>40</p>             | <p>70<br/>100</p>            | <p>70<br/>140</p>                               |
| <p>Osvětlení<br/>Lighting<br/>Освещение</p>                                | <p>30</p>                    | <p>100</p>                   | <p>140</p>                                      |
| <p>Police<br/>Shelf<br/>Полочка</p>  | <p>45<br/>15<br/>45</p>      | <p>100<br/>15<br/>100</p>    | <p>85<br/>140<br/>15<br/>85<br/>15<br/>140</p>  |
| <p>Umyvadlo<br/>Wash basin<br/>Раковина</p>                                | <p>28 45 5 25 55 45 100</p>  | <p>28 45 5 25 55 45 100</p>  | <p>28 45 5 25 55 85 140 10 45 25 55 85 140</p>  |
| <p>Výpust (Clic-Clac)<br/>Clic Clac<br/>Водослив для умывальника</p>       |                            |   |   |
| <p>Umyvadlová skříňka<br/>Wash basin cabinet<br/>Шкафчик под раковину</p>  | <p>45 45 20</p>            | <p>45 45 40</p>            | <p>45 85 20 45 85 40</p>                      |
| <p>Skříňka<br/>Cabinet<br/>Шкафчик</p>                                     | <p>96,6 40 40</p>          | <p>137,4 40 40</p>         | <p>171,5 40 40 35 15 85 35</p>                |
| <p>Krycí deska<br/>Covering board<br/>Декоративная доска</p>               | <p>3 40 40</p>             |   |   |



# LUCCA





Umývadlo  
Wash basin  
Раковина



Barevné provedení  
Colours  
Расцветка



D00

bílá  
white  
белая

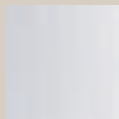

D10

bílá-struktura  
white-structure  
белая-структура

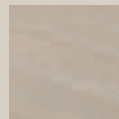

DEC

cremona

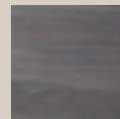

DCA

chateau

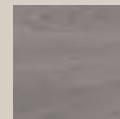

DOR

orme

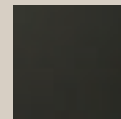

BLK

černá-struktura  
black-structure  
чёрная-структура

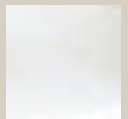

R01

bílá-lesk  
white-shiny  
белая-лоск

# LUCCA

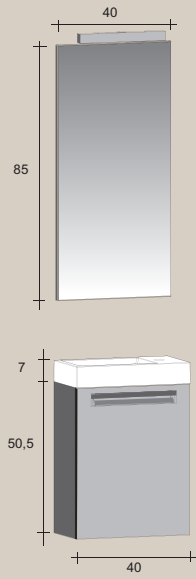

Set 01

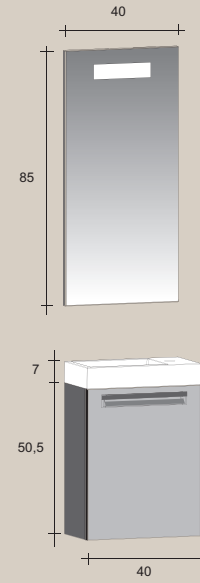

Set 02

Zrcadlo  
Mirror  
Зеркало



Zrcadlo s osvětlením  
Mirror with lighting  
Зеркало со светом



Osvětlení  
Lighting  
Освещение

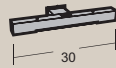

Umyvadlo  
Wash basin  
Раковина

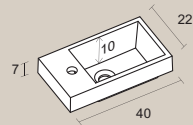

Skříňka  
Cabinet  
Шкафчик

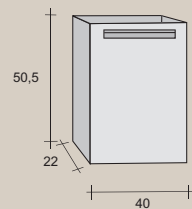



# SLIMLINE





# SLIMLINE



Umyvadlo  
Wash basin  
Раковина

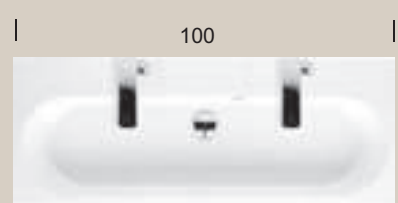
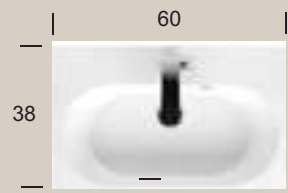

Barevné provedení  
Colours  
Расцветка



D00

bílá  
white  
белая



D10

bílá-struktura  
white-structure  
белая-структура



DEC

cremona

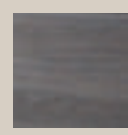

DCA

chateau

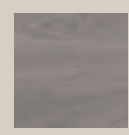

DOR

orme

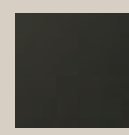

BLK

černá-struktura  
black-structure  
чёрная-структура



R01

bílá-lesk  
white-shiny  
белая-лоск

# SLIMLINE

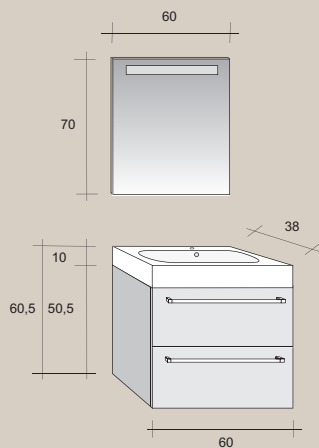

Set 01

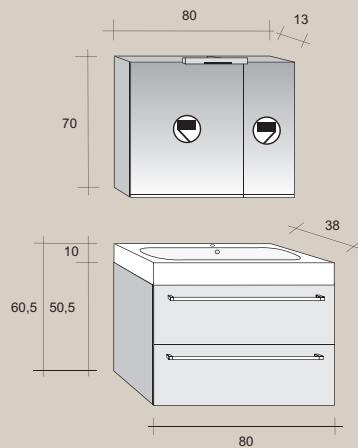

Set 06

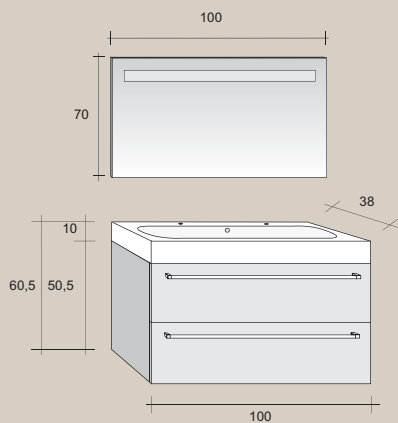

Set 15

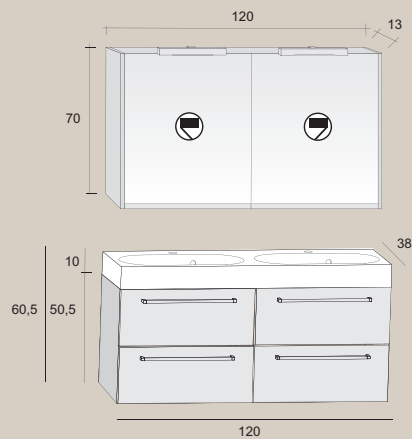



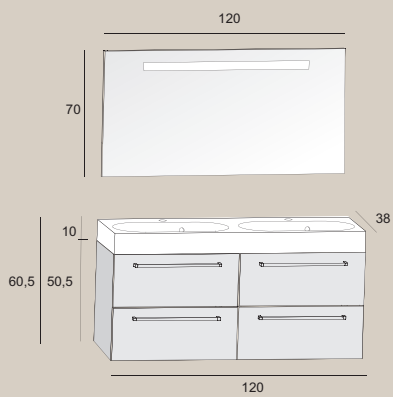

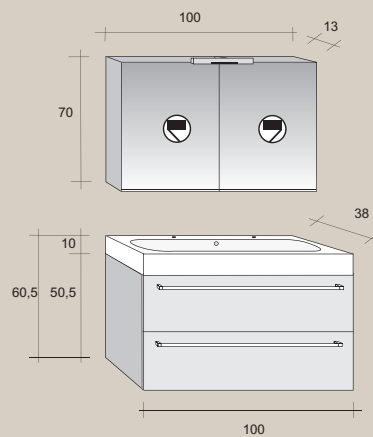

Set 21

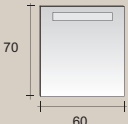
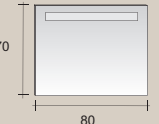
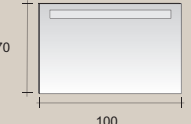
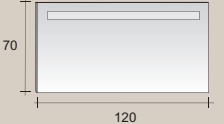
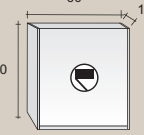
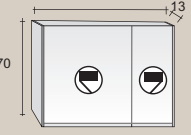
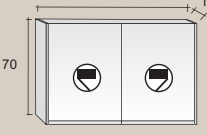
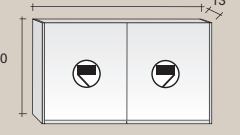
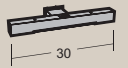
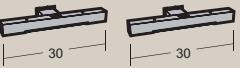

Set 20

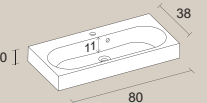
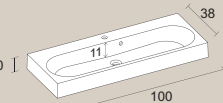
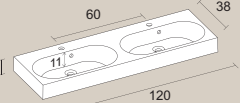
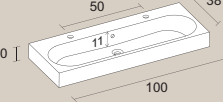
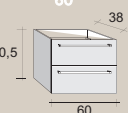
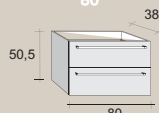
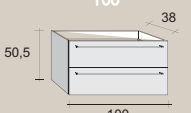
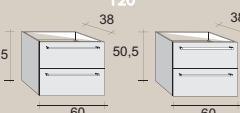
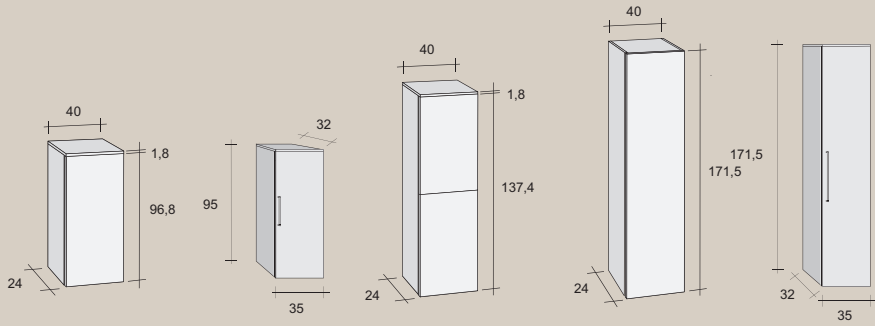

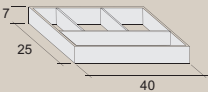
Set 16

|   |   |   |  |  |
|---|---|---|--|--|
| <p>Zrcadlo s osvětlením<br/>Mirror with lighting<br/>Зеркало со светом</p>            | <p>60<br/>70<br/>60</p>        | <p>80<br/>70<br/>80</p>        | <p>100<br/>70<br/>100</p>        | <p>120<br/>70<br/>120</p>               |
| <p>Zrcadlová skříňka<br/>Mirror cabinet<br/>Шкафчик с зеркалом</p>                    | <p>60 13<br/>70</p>            | <p>80 13<br/>70</p>            | <p>100 13<br/>70</p>             | <p>120 13<br/>70</p>                    |
| <p>Osvětlení<br/>Lighting<br/>Освещение</p>   |                                |   |  |   |
| <p>Umyvadlo<br/>Wash basin<br/>Раковина</p>   | <p>10 38<br/>60</p>            | <p>10 38<br/>80</p>            | <p>10 38<br/>100</p>             | <p>10 38<br/>60 120</p>                 |
|   |                               |   |  |  |
| <p>Umyvadlová skříňka<br/>Wash basin cabinet<br/>Шкафчик под раковину</p>             | <p>60 38<br/>50,5<br/>60</p>  | <p>80 38<br/>50,5<br/>80</p>  | <p>100 38<br/>50,5<br/>100</p>  | <p>120 38<br/>50,5 50,5<br/>60 60</p>  |
| <p>Skříňka<br/>Cabinet<br/>Шкафчик</p>  |                             |   |  |  |
| <p>Sifon chromový<br/>Chrome siphon<br/>Сифон хромовый</p>                            |                              |   |  |  |
| <p>Organizer zástavky<br/>Drawer organizer<br/>Разделение для выдвижного шкафчика</p> |                              |   |  |  |
| <p>Výpust (Clic-Clac)<br/>Clic Clac<br/>Водослив для умывальника</p>                  |                              |   |  |  |

# SMARTLINE

Nábytek / Furniture / Мебель





# SMARTLINE



Umyvadlo  
Wash basin  
Раковина

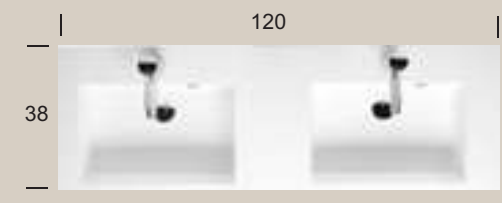
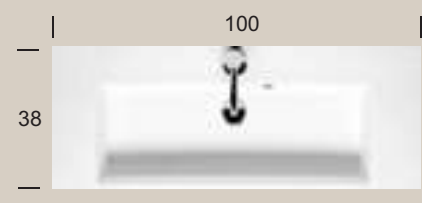
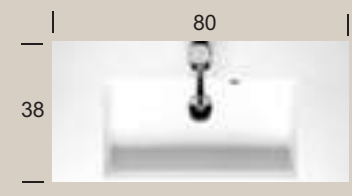

Barevné provedení  
Colours  
Расцветка



D00

bílá  
white  
белая



D10

bílá-struktura  
white-structure  
белая-структура

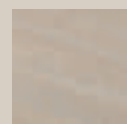

DEC

cremona

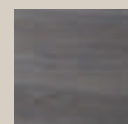

DCA

chateau

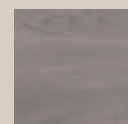

DOR

orne

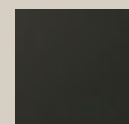

BLK

černá-struktura  
black-structure  
чёрная-структура



R01

bílá-lesk  
white-shiny  
белая-лоск

# SMARTLINE



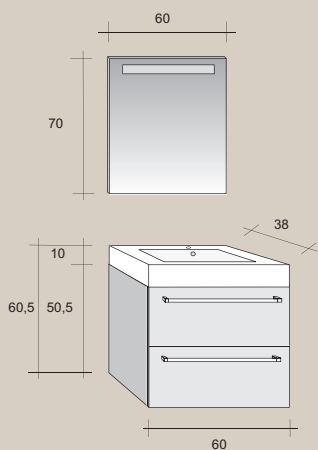

Set 01

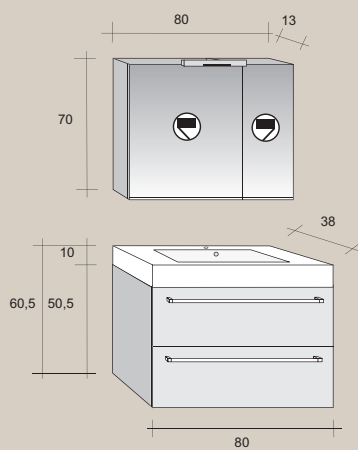

Set 06

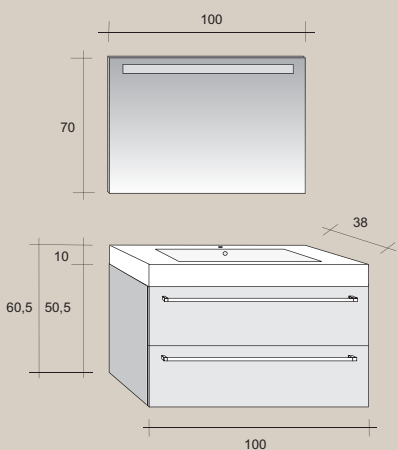

Set 10

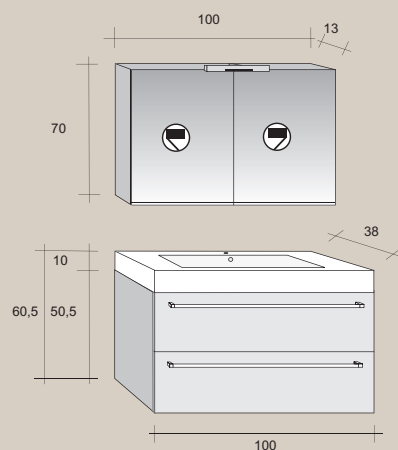

Set 11

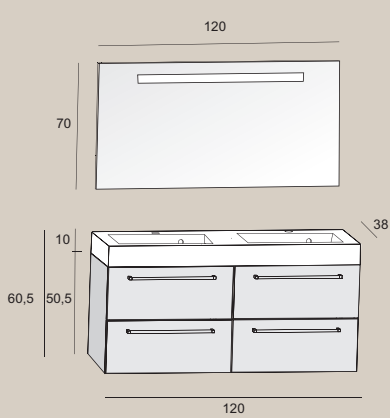



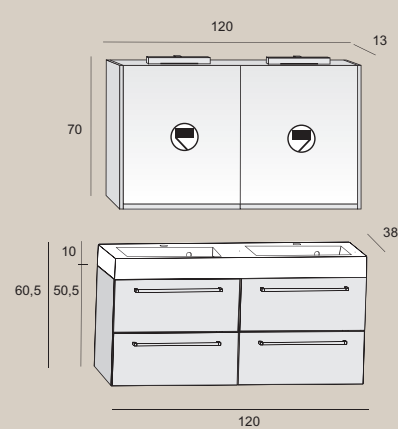





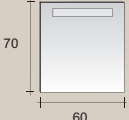
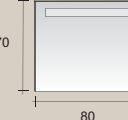

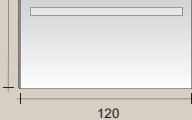
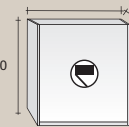
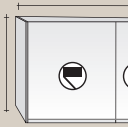
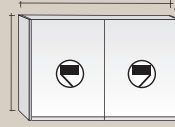



Set 20

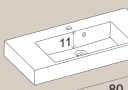

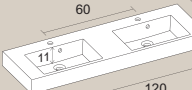
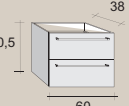
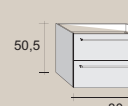
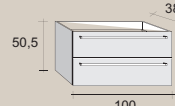
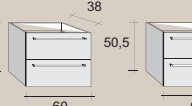
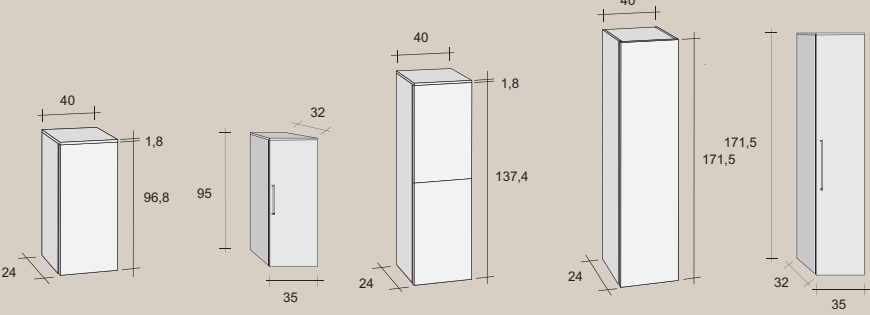
Set 21

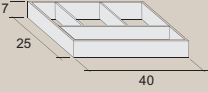
# SMARTLINE

|   |  |  |   |   |
|---|--|--|---|---|
| <p>Zrcadlo s osvětlením<br/>Mirror with lighting<br/>Зеркало со светом</p>            | <p>60<br/>70<br/>60</p>         | <p>80<br/>70<br/>80</p>         | <p>100<br/>70<br/>100</p>         | <p>120<br/>70<br/>120</p>    |
| <p>Zrcadlová skříňka<br/>Mirror cabinet<br/>Шкафчик с зеркалом</p>                    | <p>60<br/>70<br/>13<br/>60</p>  | <p>80<br/>70<br/>13<br/>80</p>  | <p>100<br/>70<br/>13<br/>100</p>  | <p>120<br/>70<br/>13<br/>120</p>   |
| <p>Osvětlení<br/>Lighting<br/>Освещение</p>   |  <p>30</p>                      |  |   |  <p>30</p>  <p>30</p> |
| <p>Umyvadlo<br/>Wash basin<br/>Раковина</p>   | <p>10<br/>60<br/>38</p>         | <p>10<br/>80<br/>38</p>         | <p>10<br/>100<br/>38</p>          | <p>10<br/>60<br/>120<br/>38</p>    |
| <p>Umyvadlová skříňka<br/>Wash basin cabinet<br/>Шкафчик под раковину</p>             | <p>50,5<br/>60<br/>38</p>       | <p>50,5<br/>80<br/>38</p>       | <p>50,5<br/>100<br/>38</p>        | <p>50,5<br/>60<br/>120<br/>38<br/>50,5<br/>60</p>    |
| <p>Skříňka<br/>Cabinet<br/>Шкафчик</p>  |                              |  |   |   |
| <p>Sifon chromový<br/>Chrome chrome siphon<br/>Сифон хромовый</p>                     |                               |  |   |   |
| <p>Organizer zástavky<br/>Drawer organizer<br/>Разделение для выдвижного шкафчика</p> |                               |  |   |   |
| <p>Výpust (Clic-Clac)<br/>Clic Clac<br/>Водослив для умывальника</p>                  |                               |  |   |   |



# SCALA



Umyvadlo  
Wash basin  
Раковина

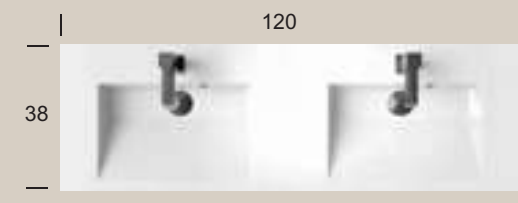
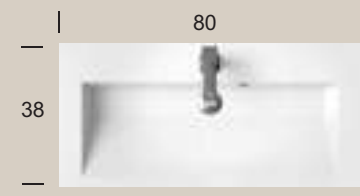

Barevné provedení  
Colours  
Расцветка



|                        |  |         |         |      |  |  |
|------------------------|--|---------|---------|------|--|--|
| D00                    | D10  | DEC     | DCA     | DOR  | BLK  | R01                                    |
| bílá<br>white<br>белая | bílá-struktura<br>white-structure<br>белая-структура | cremona | chateau | orme | černá-struktura<br>black-structure<br>чёрная-структура | bílá-lesk<br>white-shiny<br>белая-лоск |

# SCALA

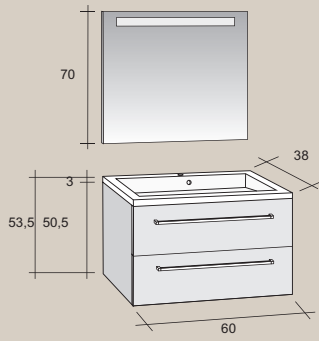

Set 01

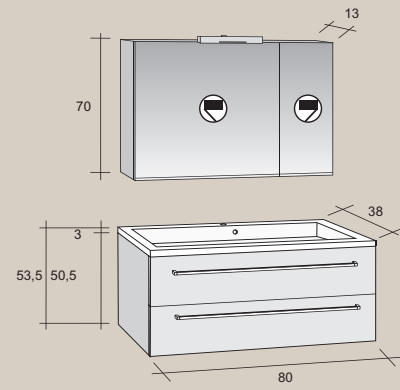



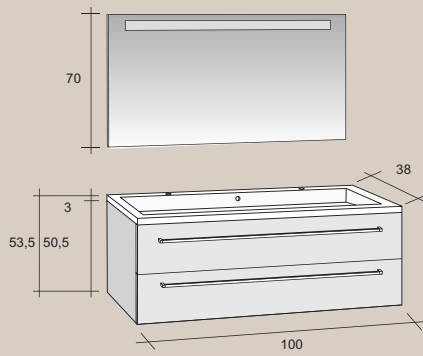



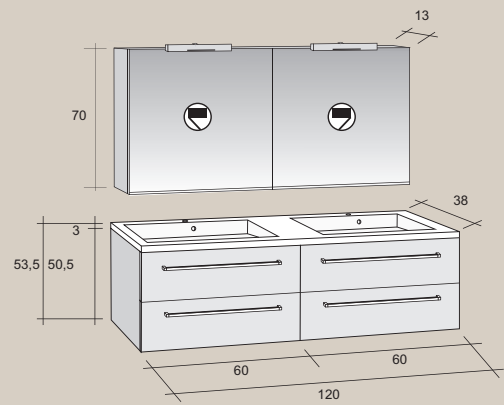

Set 06

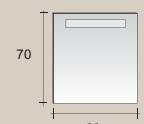

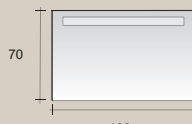
Set 15

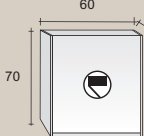
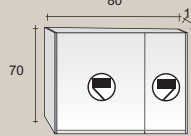
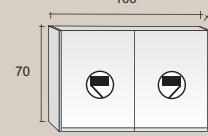
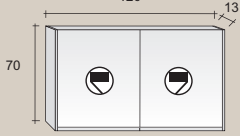
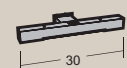

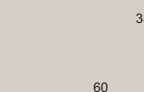
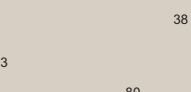
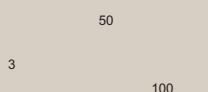
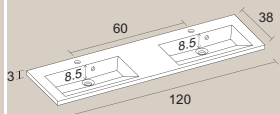
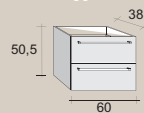
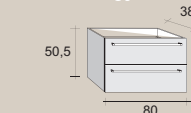
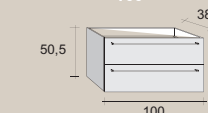
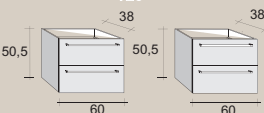
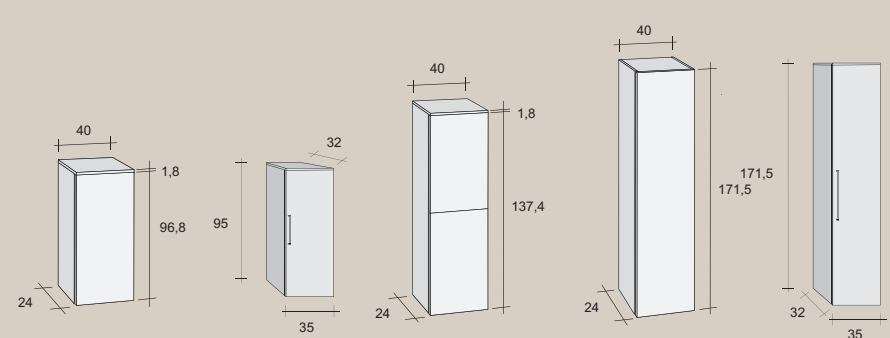
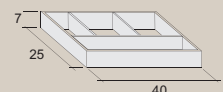
Set 21

|   |  |  |   |   |
|---|--|--|---|---|
| <p>Zrcadlo s osvětlením<br/>Mirror with lighting<br/>Зеркало со светом</p>            | <p>60<br/>70<br/>60</p>   | <p>80<br/>70<br/>80</p>   | <p>100<br/>70<br/>100</p>   | <p>120<br/>70<br/>120</p>          |
| <p>Zrcadlová skříňka<br/>Mirror cabinet<br/>Шкафчик с зеркалом</p>                    | <p>60 13<br/>70</p>       | <p>80 13<br/>70</p>       | <p>100 13<br/>70</p>        | <p>120 13<br/>70</p>               |
| <p>Osvětlení<br/>Lighting<br/>Освещение</p>   |                           |  |   |                                    |
| <p>Umyvadlo<br/>Wash basin<br/>Раковина</p>   | <p>3 38<br/>60</p>        | <p>3 38<br/>80</p>        | <p>3 38<br/>100</p>         | <p>3 38<br/>60 8,5 120</p>         |
| <p>Umyvadlová skříňka<br/>Wash basin cabinet<br/>Шкафчик под раковину</p>             | <p>60 38<br/>50,5 60</p>  | <p>80 38<br/>50,5 80</p>  | <p>100 38<br/>50,5 100</p>  | <p>120 38<br/>50,5 60 50,5 60</p>  |
| <p>Skříňka<br/>Cabinet<br/>Шкафчик</p>  |                        |  |   |   |
| <p>Organizer zástavky<br/>Drawer organizer<br/>Разделение для выдвижного шкафчика</p> |                         |  |   |   |
| <p>Výpust (Clic-Clac)<br/>Clic Clac<br/>Водослив для умывальника</p>                  |                         |  |   |   |

# VOLANO



Umyvadlo  
Wash basin  
Раковина

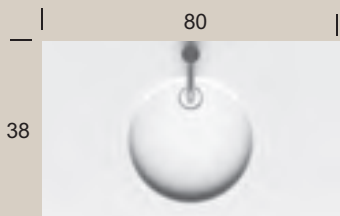
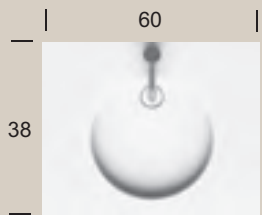

Barevné provedení  
Colours  
Расцветка



D00

bílá  
white  
белая

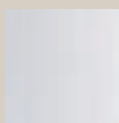

D10

bílá-struktura  
white-structure  
белая-структура

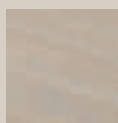

DEC

cremona

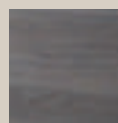

DCA

chateau

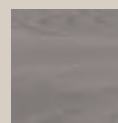

DOR

orme

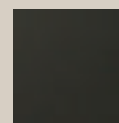

BLK

černá-struktura  
black-structure  
чёрная-структура



R01

bílá-lesk  
white-shiny  
белая-лоск

# VOLANO

Nábytek/Furniture/Мебель

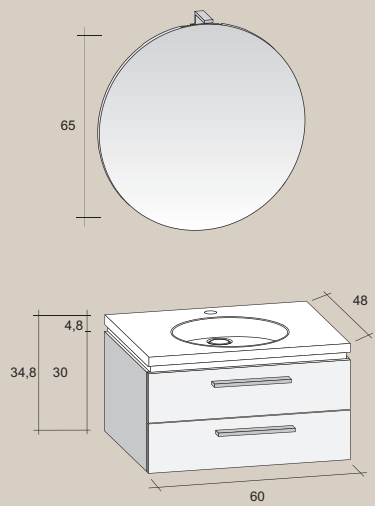

Set 02

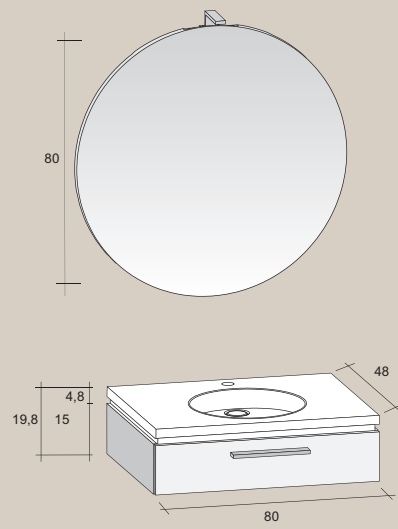

Set 05

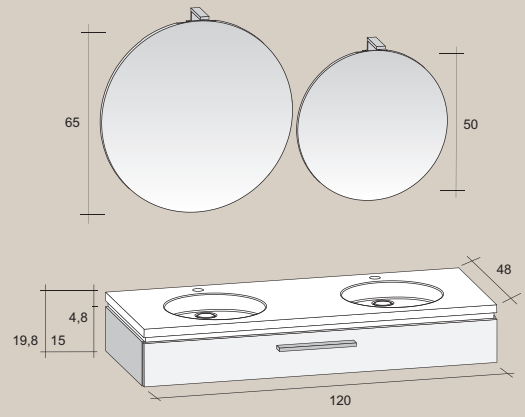

Set 15

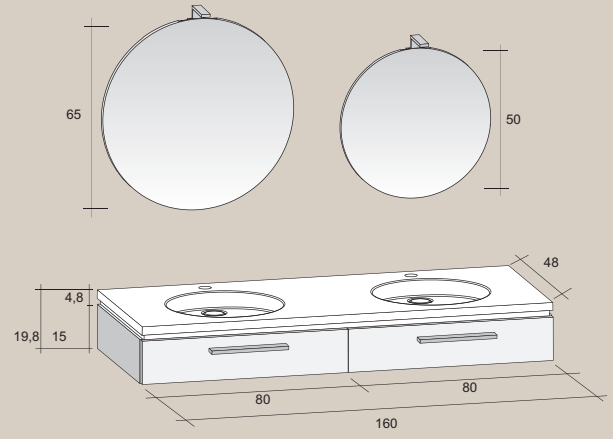

Set 25

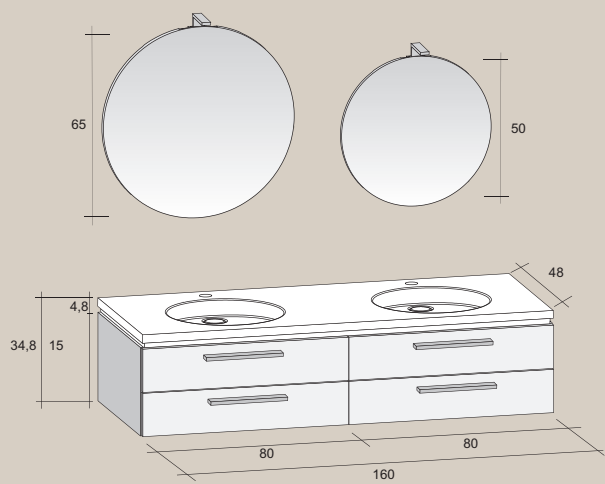

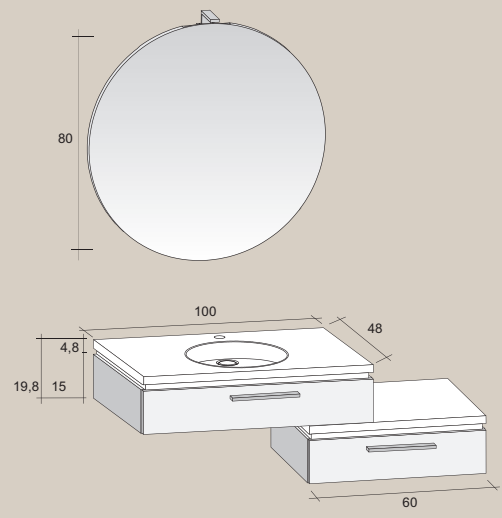

Set 26





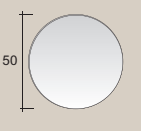
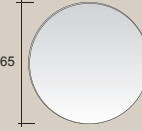
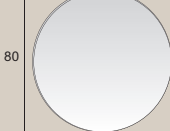
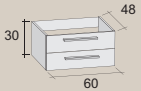
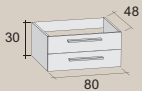
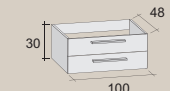
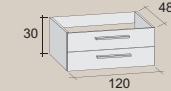
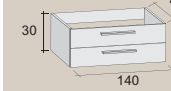
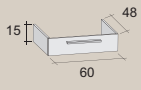
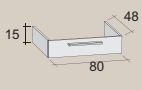
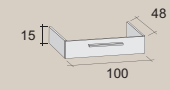
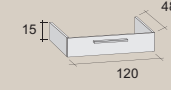
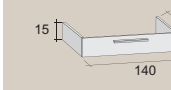
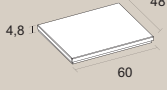
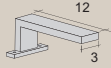
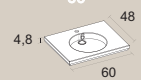
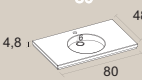
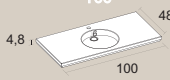
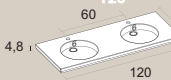

Set 35

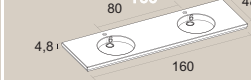
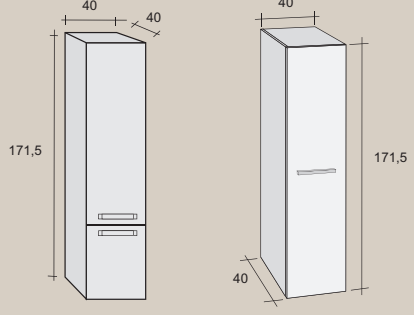
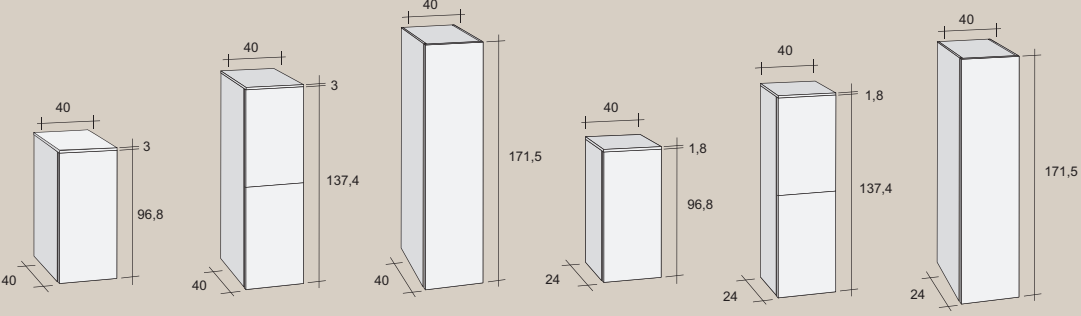

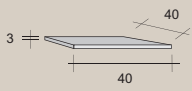
# VOLANO

|   |   |   |  |  |  |  |
|---|---|---|--|--|--|--|
| <p>Zrcadlo<br/>Mirror<br/>Зеркало</p>   | <p>50</p>    | <p>65</p>    | <p>80</p>     |  |  |  |
| <p>Umyvadlová skříňka<br/>Wash basin cabinet<br/>Шкафчик под раковину</p>   | <p>60</p>    | <p>80</p>    | <p>100</p>    | <p>120</p>    | <p>140</p>    |  |
| <p>Umyvadlová skříňka<br/>Wash basin cabinet<br/>Шкафчик под раковину</p>   | <p>60</p>    | <p>80</p>    | <p>100</p>    | <p>120</p>    | <p>140</p>    |  |
| <p>Krycí deska na umyvadlovou skříňku<br/>Cover desk on wash basin cabinet<br/>Декоративная доска для шкафчика под раковину</p> |              |   |  |  |  |  |
| <p>Osvětlení<br/>Lighting<br/>Освещение</p>   |             |   |  |  |  |  |
| <p>Umyvadlo<br/>Wash basin<br/>Раковина</p>   | <p>60</p>  | <p>80</p>  | <p>100</p>  | <p>120</p>  | <p>140</p>  | <p>160</p>  |
| <p>Skříňka cabinet<br/>Шкафчик</p>  |            |   |  |  |  |  |
| <p>Skříňka cabinet<br/>Шкафчик</p>  |           |   |  |  |  |  |

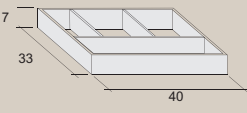
|  |  |  |
|--|--|--|
| <p>Krycí deska<br/>Covering board<br/>Декоративная доска</p>                         |   |  |
| <p>Sifon chromový<br/>Chrome siphon<br/>Разделение для выдвижного шкафчика</p>       |   |  |
| <p>Mistospořicí sifon<br/>Space-saving siphon<br/>Сифон экономит место</p>           |   |  |
| <p>Výpust (Clic-Clac)<br/>Clic Clac<br/>Водослив для умывальника</p>                 |   |  <p><i>Special (nízky)</i><br/><i>Special (low)</i><br/><i>Специальный (низкий)</i></p> |
| <p>Organizér zásuvky<br/>Drawer organizer<br/>Разделение для выдвижного шкафчика</p> |  |  |



Umyvadlo  
Wash basin  
Раковина

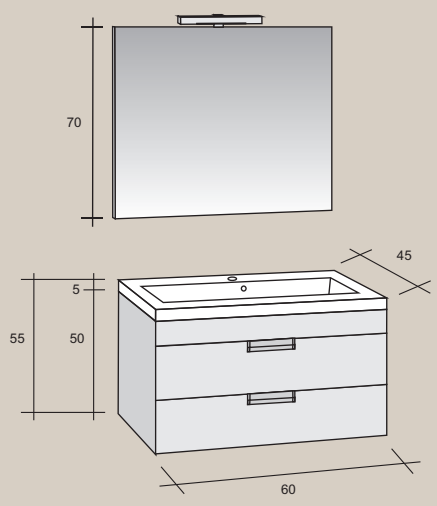
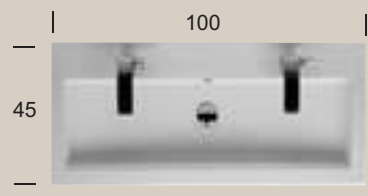
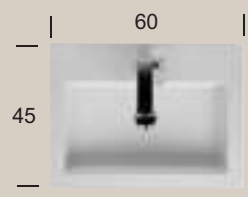

Set 01

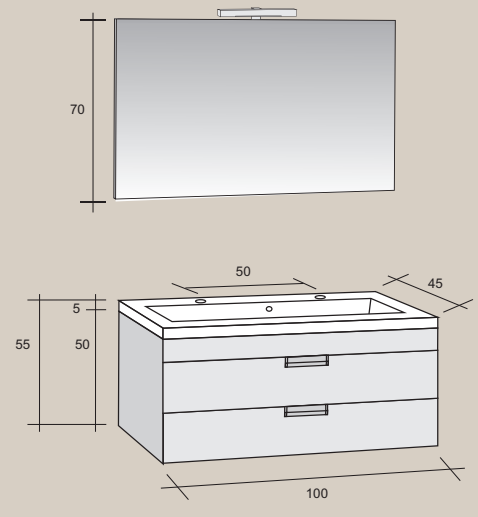

Set 03

Umyvadlo  
Wash basin  
Раковина

Skříňka  
Cabinet  
Шкафчик

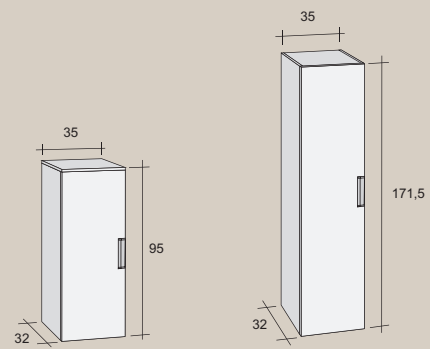

Barevné provedení  
Colours  
Расцветка

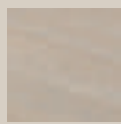

DEC

cremona

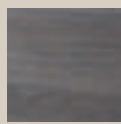

DCA

chateau

# Poznámky / Notes / Записки

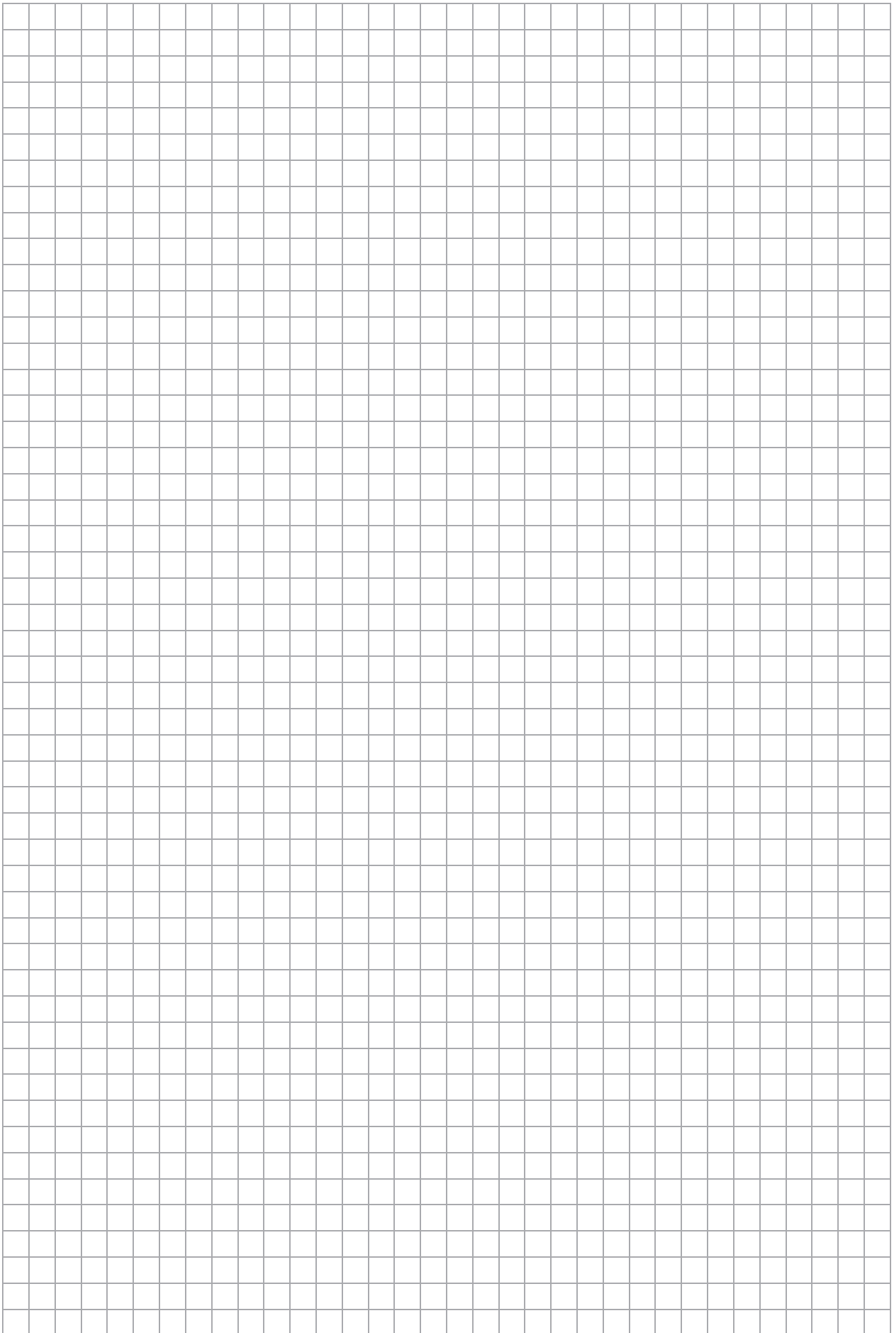



EVROPSKÁ UNIE  
EVROPSKÝ FOND PRO REGIONÁLNÍ ROZVOJ  
INVESTICE DO VAŠÍ BUDOUCNOSTI



EUROPEAN UNION  
EUROPEAN REGIONAL DEVELOPMENT FUND  
INVESTMENT IN OYUR FUTURE



ЕВРОПЕЙСКИЙ СОЮЗ  
ЕВРОПЕЙСКИЙ ФОНД РЕГИОНАЛЬНОГО РАЗВИТИЯ  
ИНВЕСТИЦИИ В ВАШЕ БУДУЩЕЕ

MOSBUILD 2013

VÁŠ PRODEJCE RIHO / YOUR RIHO ADVISOR:

**RIHO CZ, a.s.**

Suchý 37, 680 01 Boskovice  
Czech Republic  
tel.: +420 516 468 222  
fax: +420 516 468 216  
info@riho.cz



Výrobce si vyhrazuje právo technických a cenových změn.  
The right to change price and technical characteristics  
is reserved by the manufacturer.

[www.riho.cz](http://www.riho.cz)

[www.riho.ru](http://www.riho.ru)

[www.riho.sk](http://www.riho.sk)

[www.riho.by](http://www.riho.by)

[www.riho.si](http://www.riho.si)

[www.rihoro.ro](http://www.rihoro.ro)